

IRIS
MINIDL07RD
Minidownlight empotrable
redondo de 7W regulable



FICHA TÉCNICA · DATOS DEL PRODUCTO

| Datos eléctricos | |
|---|--|
| Entrada | 220 ~ 240Vac |
| Frecuencia de red | 50/60Hz |
| Potencia | 7W |
| Factor Potencia | > 0,5 |
| Nº de LEDs | 7 Chips SMD 3528 |
| Potencia del LED | 1W |
| Clase protección IEC | Clase II |
| Datos fotométricos | |
| Eficiencia luminosa | 87lm/W |
| CRI (Ra) | >80 |
| Flujo luminoso (Nominal / Real) CCT | 700lm · 609lm · 5700K · BF 679lm · 588lm · 4000K · BN 651lm · 560lm · 2700K · BC |
| Intensidad luminosa | 870cd |
| SDCM Desviación estándar ajuste de color | <3 |
| Grado de apertura | 45° / 90° |
| Temp. Trabajo | -20°C ~ +45°C |
| Nº conmutaciones | 15.000 |
| Certificaciones | CE, RoHS |
| Eficiencia Energética | A+ |
| Vida útil | 30000 (L70:B10) |
| Materiales y características físicas | |
| Cuerpo | Termoplástico |
| Difusor | Policarbonato |
| Acabado | Blanco RAL 9010 |
| Medidas en mm (diámetro x alto) | Ø94 X 44,8 |
| Peso (g) | 74,5 |
| Características | |
| Grado IP | IP20 |
| Flicker | No |
| Opciones | |
| Posibilidad de regulación | TRIAC |
| Posibilidad de Kit de Emergencia | Opcional (KEL101) |
| Embalaje | |
| Medida packaging | 495 X 406 X 307 |
| Peso packaging (kg) | 10,6 |
| Unidades (unidades/caja exterior) | 100 unidades |

Medidas en mm

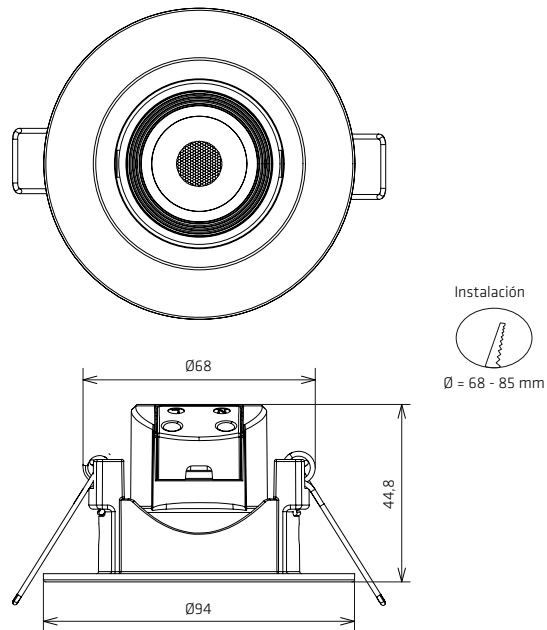

Ópticas

Ángulo de apertura 45°



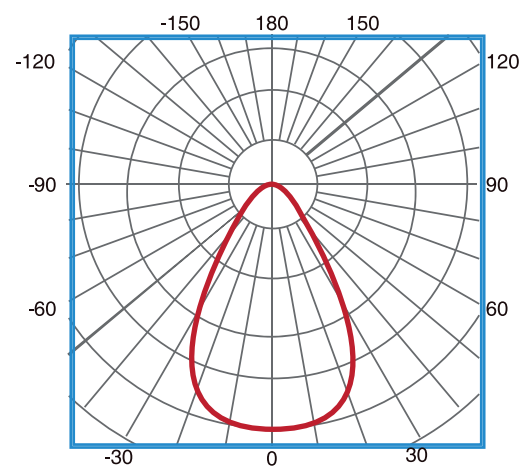
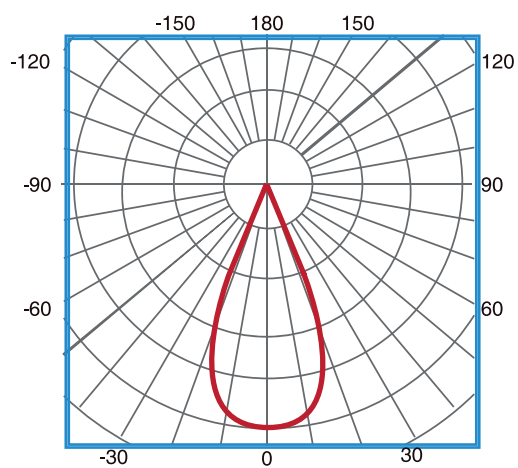

| H (m) | Diámetro (m) | E _{max} (lx) |
|-------|--------------|-----------------------|
| 1 | 0,680 | 1243 |
| 2 | 1,360 | 311 |
| 3 | 2,040 | 138 |

Ángulo de apertura 90°

| H (m) | Diámetro (m) | E _{max} (lx) |
|-------|--------------|-----------------------|
| 1 | 2,54 | 255 |
| 2 | 5,08 | 64 |
| 3 | 7,61 | 28 |



Referencias

|  |  | W |  |  |  | CCT | CRI |
|---|---|-----|---|--|---|-----------|------|
| MINIDLO7RBF45 | BL | 7 W | 700 lm | 609 lm | 45° | BF: 5700K | > 80 |
| MINIDLO7RBF45 | BL | 7 W | 679 lm | 588 lm | 45° | BN: 4000K | > 80 |
| MINIDLO7RBC45 | BL | 7 W | 651 lm | 560 lm | 45° | BC: 2700K | > 80 |
| MINIDLO7RBF90 | BL | 7 W | 700 lm | 609 lm | 90° | BF: 5700K | > 80 |
| MINIDLO7RBF90 | BL | 7 W | 679 lm | 588 lm | 90° | BN: 4000K | > 80 |
| MINIDLO7RBC90 | BL | 7 W | 651 lm | 560 lm | 90° | BC: 2700K | > 80 |

