

## PL40E

Lámpara Led CFL-PL G24 9W

### Producto



### Dimensiones

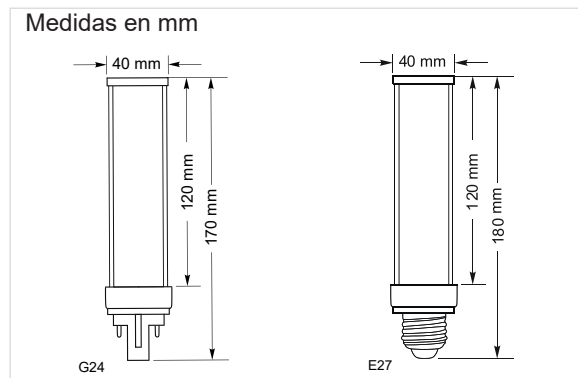

### Datos Técnicos

Entrada:	175~240Vac 50/60Hz
Potencia:	9W
Nº de LEDs:	20 chips SMD5630 SAMSUNG
Factor Potencia:	>0.80
Eficiencia Lumínica:	95 lm/w
Potencia LED:	0.47W
Flujo Luminoso:	855 lm (BF) 836 lm (BN) 827 lm (BC)
Intensidad Lumínica:	280cd
Grado de IP:	IP20
Temp. Trabajo:	-20°C +50°C
Nº Conmutaciones:	15.000
Certificaciones:	CE, RoHS
Eficiencia Energética:	A+
Vida útil:	30.000h (L70:B10)
Peso:	110 gramos

### Datos Fotométricos

**Ángulo de apertura** =120°  
**Flujo Luminoso** =855 lm  
**Tª de color CCT** =5700K (BF)  
**CRI** =>85

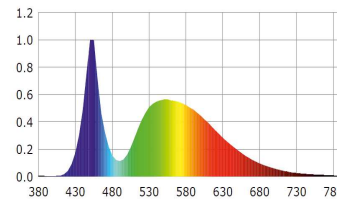

Luz Fría 120°

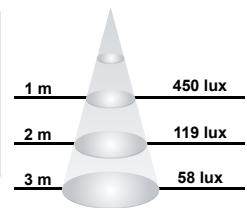

**Ángulo de apertura** =120°  
**Flujo Luminoso** =836 lm  
**Tª de color CCT** =4000K (BN)  
**CRI** =>85

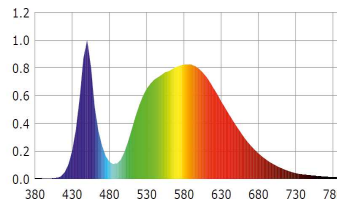

Luz Neutra 120°

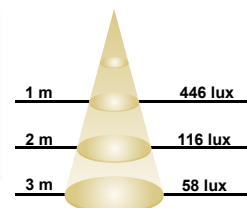

**Ángulo de apertura** =120°  
**Flujo Luminoso** =827 lm  
**Tª de color CCT** =3000K (BC)  
**CRI** =>85

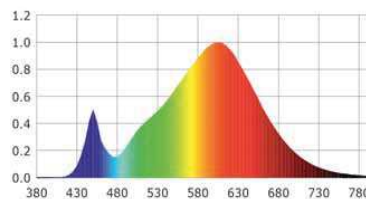

Luz Cálida 120°

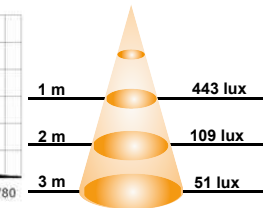

Curva de Distribución Lumínica

Luz Neutra

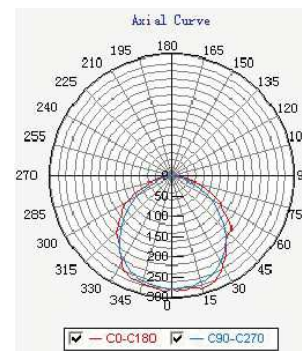

Chip utilizado

