

EFAPEL®

Empresa Fabril de Produtos Eléctricos, S.A.

SÉRIE 10 - MOLDURAS E CALHAS DE RODAPÉ

MINIATURE CABLE TRUNKINGS AND SKIRT CABLE TRUNKINGS - 10 SERIES

SÉRIE 10 - MOULURES ET PLINTHES

SERIE 10 - MOLDURAS Y CANALES DE ZOCÁLO

MODELLREIHE 10 - RAHMUNGEN UND FUBLEISTEN MIT KABELKANAL

СЕРИЯ 10 - МИНИКАНАЛЫ И КАБЕЛЬНЫЙ ПЛИНТУС

**12x7; 16x10; 20x12,5; 32x12,5; 32x16; 40x12,5; 40x16; 60x16;
50x20; 75x20; 110x20**

PT | EN | FR | ES | DE | RU

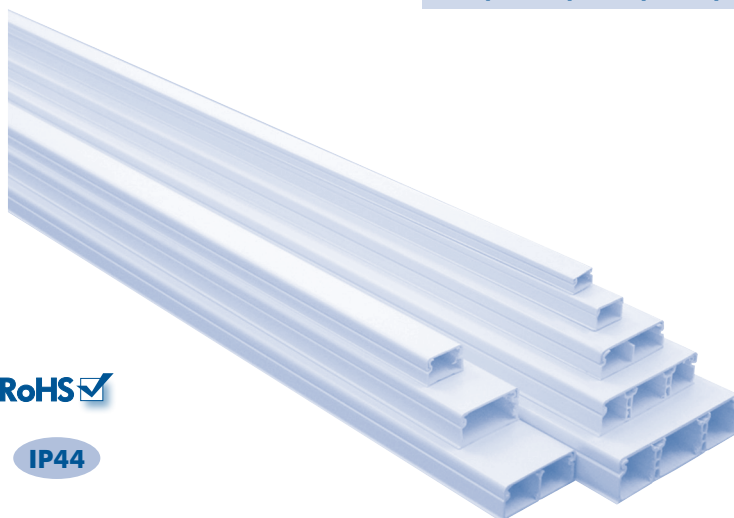

RoHS ✓

IP44

Folheto Informativo n.º 4/2017 (290 206)

Serpins
3200-355 Serpins
PORTUGAL

PORTUGAL

+351 239 970 136
800 202 344
comercial@efapel.com

ESPAÑA

900 535 746
+351 239 970 139
espana@efapel.com

EXPORT

+351 239 970 135
+351 239 970 139
export@efapel.com

SAT

+351 239 970 132
sat@efapel.com
www.efapel.com

SÉRIE 10 - MOLDURAS E CALHAS DE RODAPÉ - PT 3

**MINIATURE CABLE TRUNKINGS AND
SKIRT CABLE TRUNKINGS - 10 SERIES - EN** 8

SÉRIE 10 - MOULURES ET PLINTHES - FR 13

SERIE 10 - MOLDURAS Y CANALES DE ZOCÁLO - ES 18

**MODELLREIHE 10 - RAHMUNGEN UND FUSSLEISTEN MIT
KABELKANAL - DE** 23

СЕРИЯ 10 - МИНИКАНАЛЫ И КАБЕЛЬНЫЙ ПЛИНТУС - RU 28

ESQUEMA DE MONTAGEM DE ACESSÓRIOS

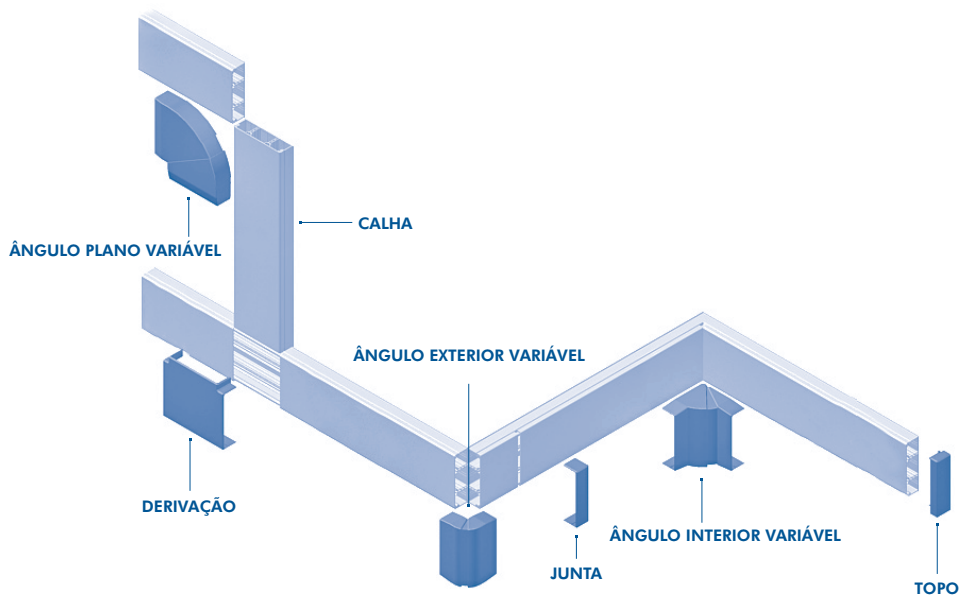

DESIGNAÇÃO REF.º	MEDIDAS EXTERIORES(MM)	PROTEÇÃO CONTRA IMPACTOS MECÂNICOS EXTERNOS - IK
Calha 10010 CBR	12x7	05
Calha 10010 FBR Adesiva		
Calha 10020 CBR	16x10	07
Calha 10020 FBR Adesiva		
Calha 10030 CBR	20x12,5	07
Calha 10030 FBR Adesiva		
Calha 10400 CBR	32x12,5	07
Calha 10400 FBR Adesiva		
Calha 10410 CBR sem Divisória		
Calha 10410 FBR sem Divisória Adesiva		
Calha 10040 CBR	32x16	07
Calha 10040 FBR Adesiva		
Calha 10050 CBR	40x12,5	07
Calha 10050 FBR Adesiva		
Calha 10150 CBR sem Divisória		
Calha 10150 FBR sem Divisória Adesiva		
Calha 10060 CBR	40x16	07
Calha 10060 FBR Adesiva		
Calha 10160 CBR sem Divisória		
Calha 10160 FBR sem Divisória Adesiva		
Calha 10070 CBR	60x16	07
Calha 10170 CBR sem Divisórias		
Calha 10500 CBR	50x20	07
Calha 10510 CBR		
Calha 10520 CBR		
Calha 10140 CBR	75x20	07
Calha 10100 CBR	110x20	05

REFERÊNCIAS

CALHA	ACESSÓRIO
10010 CBR	10011 ABR
10010 FBR	
10020 CBR	10021 ABR
10020 FBR	
10030 CBR	10031 ABR
10030 FBR	
10400 CBR	10401 ABR
10400 FBR	
10410 CBR	
10410 FBR	
10040 CBR	10041 ABR
10040 FBR	
10050 CBR	10051 ABR
10050 FBR	
10150 CBR	
10150 FBR	
10060 CBR	
10060 FBR	10061 ABR
10160 CBR	
10160 FBR	
10070 CBR	
10170 CBR	
10500 CBR	10501 ABR
10510 CBR	
10520 CBR	
10140 CBR	10141 ABR

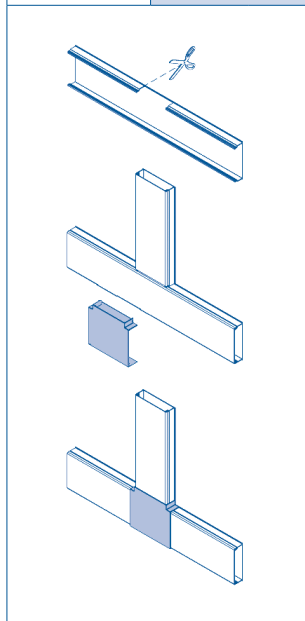

CALHA	ACESSÓRIO
10010 CBR	10012 ABR
10010 FBR	
10020 CBR	10022 ABR
10020 FBR	
10030 CBR	10032 ABR
10030 FBR	
10400 CBR	10402 ABR
10400 FBR	
10410 CBR	
10410 FBR	
10040 CBR	10042 ABR
10040 FBR	
10050 CBR	10052 ABR
10050 FBR	
10150 CBR	
10150 FBR	
10060 CBR	
10060 FBR	10062 ABR
10160 CBR	
10160 FBR	
10070 CBR	
10170 CBR	
10500 CBR	10502 ABR
10510 CBR	
10520 CBR	
10140 CBR	10142 ABR

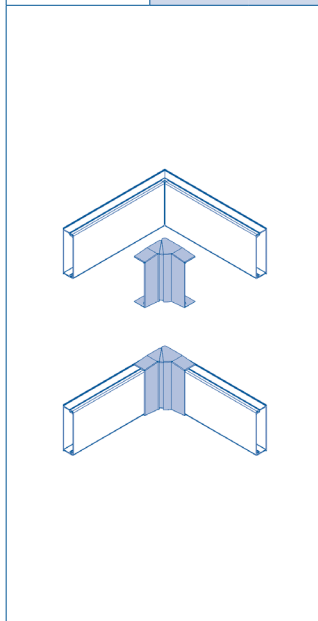

CALHA	ACESSÓRIO
10010 CBR	10013 ABR
10010 FBR	
10020 CBR	10023 ABR
10020 FBR	
10030 CBR	10033 ABR
10030 FBR	
10400 CBR	10403 ABR
10400 FBR	
10410 CBR	
10410 FBR	
10040 CBR	10043 ABR
10040 FBR	
10050 CBR	10053 ABR
10050 FBR	
10150 CBR	
10150 FBR	
10060 CBR	
10060 FBR	10063 ABR
10160 CBR	
10160 FBR	
10070 CBR	
10170 CBR	
10500 CBR	10503 ABR
10510 CBR	
10520 CBR	
10140 CBR	10143 ABR

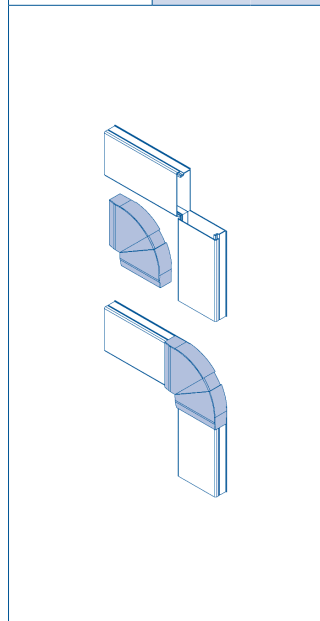

REFERÊNCIAS

CALHA	ACESSÓRIO
10010 CBR	10014 ABR
10010 FBR	
10020 CBR	10024 ABR
10020 FBR	
10030 CBR	10034 ABR
10030 FBR	
10400 CBR	10404 ABR
10400 FBR	
10410 CBR	
10410 FBR	
10040 CBR	10044 ABR
10040 FBR	
10050 CBR	10054 ABR
10050 FBR	
10150 CBR	
10150 FBR	
10060 CBR	
10060 FBR	10064 ABR
10160 CBR	
10160 FBR	
10070 CBR	10074 ABR
10170 CBR	
10500 CBR	10504 ABR
10510 CBR	
10520 CBR	
10140 CBR	10144 ABR

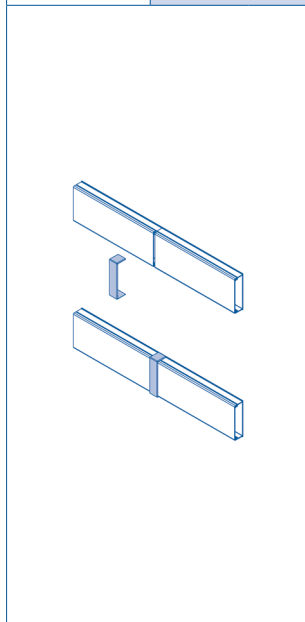

CALHA	ACESSÓRIO
10010 CBR	10015 ABR
10010 FBR	
10020 CBR	10025 ABR
10020 FBR	
10030 CBR	10035 ABR
10030 FBR	
10400 CBR	10405 ABR
10400 FBR	
10410 CBR	
10410 FBR	
10040 CBR	10045 ABR
10040 FBR	
10050 CBR	10055 ABR
10050 FBR	
10150 CBR	
10150 FBR	
10060 CBR	
10060 FBR	10065 ABR
10160 CBR	
10160 FBR	
10070 CBR	10075 ABR
10170 CBR	
10500 CBR	10505 ABR
10510 CBR	
10520 CBR	
10140 CBR	10145 ABR

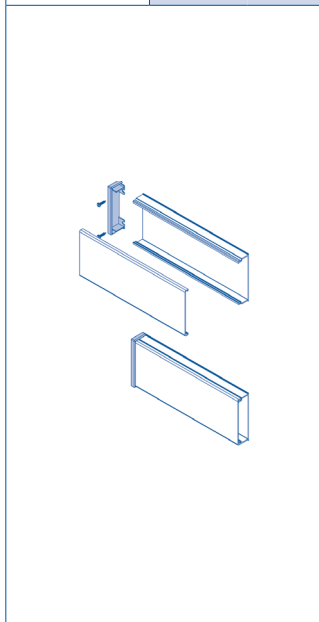

CALHA	ACESSÓRIO
10010 CBR	10016 ABR
10010 FBR	
10020 CBR	10026 ABR
10020 FBR	
10030 CBR	10036 ABR
10030 FBR	
10400 CBR	10406 ABR
10400 FBR	
10410 CBR	
10410 FBR	
10040 CBR	10046 ABR
10040 FBR	
10050 CBR	10056 ABR
10050 FBR	
10150 CBR	
10150 FBR	
10060 CBR	
10060 FBR	10066 ABR
10160 CBR	
10160 FBR	
10070 CBR	10076 ABR
10170 CBR	
10500 CBR	10506 ABR
10510 CBR	
10520 CBR	
10140 CBR	10146 ABR

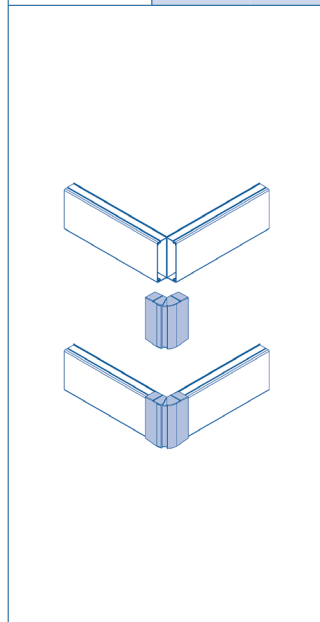

MONTAGEM DE APARELHAGEM

SÉRIE LOGUS 90 | SIRIUS 70 | APOLO 5000

1. Fixar a calha e a caixa saliente.

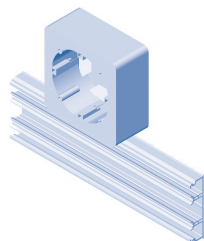

2. Fazer as ligações e montar o mecanismo.

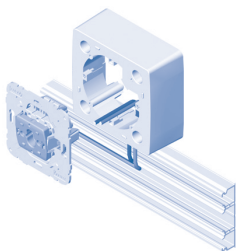

3. Aplicar a tampa da calha, o adaptador, o espelho e teclas/centros.

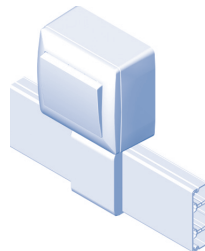

SÉRIE QUADRO 45 (apenas em calha 60x16 e 75x20)

1. Fixar a calha. Após a fixação da calha, aplicar o adaptador Série Q45.

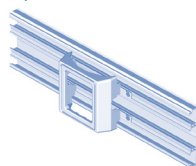

2. Fazer as ligações e montar o mecanismo.

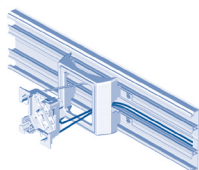

3. Aplicar a tampa da calha e centros.

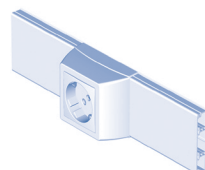

SÉRIE 3700

1. Fixar a calha. Após a fixação da calha, fixar a base e o mecanismo à parede.

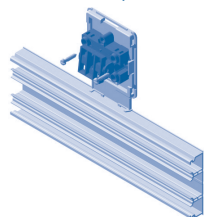

2. Efetuar as ligações.

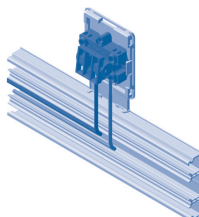

3. Aplicar a caixa do aparelho, tecla/centro, a tampa da calha e o adaptador.

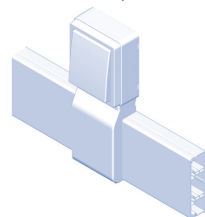

SÉRIE 47 (apenas em calha 60x16 e 75x20)

1. Fixar a calha. Fixar a base do adaptador e o aparelho à parede.

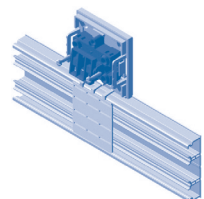

2. Cortar o isolador e efetuar as ligações.

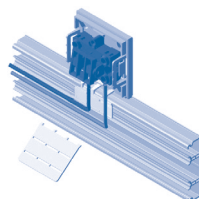

3. Aplicar a tampa da calha, o adaptador, espelho e teclas/centros.

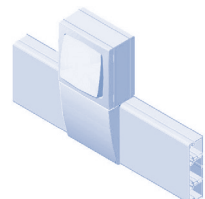

CAIXAS DEDICADAS

CAIXA SALIENTE PARA APARELHAGEM TIPO ITALIANO

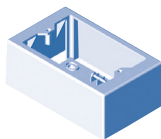

CAIXA DE DERIVAÇÃO 80x80x20

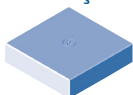

CAIXA DE DERIVAÇÃO 80x80x30



CAIXA DE DERIVAÇÃO 110x110x50

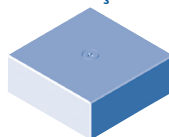

NORMA EN 50085-2-1

SECÇÃO 6	CLASSIFICAÇÃO	SÉRIE 10 - MOLDURAS E CALHAS DE RODAPÉ	
6.2	Resistência ao choque para instalação e aplicação	12x7	0,5J
		110x20	1J
		16x10 / 20x12,5 / 32x12,5 / 32x16 / 40x12,5 / 40x16 / 60x16 / 50x20 / 75x20	2J
6.3	Temperatura mínima de stock e transporte	-25°C	
6.3	Temperatura mínima de instalação e utilização	-5°C	
6.3	Temperatura máxima de utilização	60°C	
6.4	Resistência de propagação da chama	Não propagador de chama	
6.5	Continuidade elétrica	Sem continuidade elétrica	
6.6	Características de isolamento elétrico	Com isolamento elétrico	
6.7	Grau de proteção dado pelo invólucro	IP44	
6.8	Proteção contra substâncias corrosivas ou poluentes	Com média proteção no exterior e no interior	
6.9	Sistema de acesso à retenção da tampa	A tampa só pode ser aberta com uma ferramenta	
6.10	Separação de proteção elétrica	Com separação de proteção elétrica (divisória)	
6.101	Posições de instalação previstas	Saliente, fixa à parede ou ao teto	
6.102	Prevenção no contacto, entre líquidos e condutores isolados e partes ativas, no caso de calhas com montagem em posição de rodapé em chão molhado.	Não declarado	
6.103	Tipo	3 (Instalação)	
	Tensão Nominal Declarada	500V~	



RoHS - Todas as Calhas e respetivos Acessórios EFAPEL satisfazem as especificações da Diretiva RoHS 2011/65/UE que restringe a utilização de substâncias ou preparações perigosas, contendo chumbo, mercúrio, cádmio, cromo hexavalente, polibromado (PBB) e/ou éter de difenilo polibromado (PBDE).

A EFAPEL reserva o direito de modificar este documento ou os produtos nele contidos sem aviso prévio. Em caso de dúvida, contacte a EFAPEL.

EFAPEL[®]

ASSEMBLY DIAGRAM ACCESSORIES

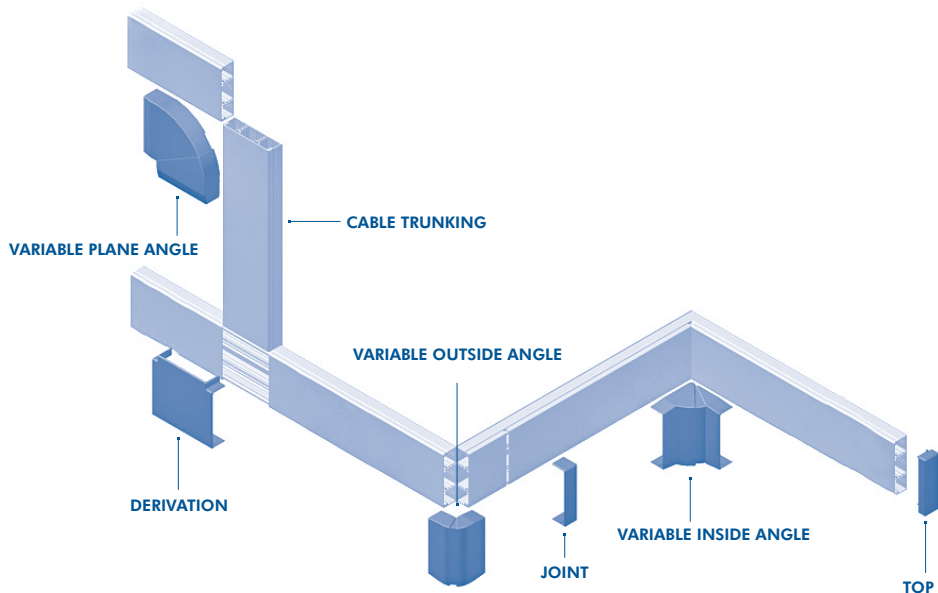

DESIGNATION REF.	OUTSIDE DIMENSIONS (MM)	PROTECTION AGAINST THE MECHANICAL SHOCKS - IK
10010 CBR Trunking	12x7	05
10010 FBR Adhesive Trunking		
10020 CBR Trunking	16x10	07
10020 FBR Adhesive Trunking		
10030 CBR Trunking	20x12,5	07
10030 FBR Adhesive Trunking		
10400 CBR Trunking	32x12,5	07
10400 FBR Adhesive Trunking		
10410 CBR without Divider		
10410 FBR Adhesive without Divider		
10040 CBR Trunking	32x16	07
10040 FBR Adhesive Trunking		
10050 CBR Trunking	40x12,5	07
10050 FBR Adhesive Trunking		
10150 CBR without Divider		
10150 FBR Adhesive without Divider		
10060 CBR Trunking	40x16	07
10060 FBR Adhesive Trunking		
10160 CBR without Divider		
10160 FBR Adhesive without Divider		
10070 CBR Adhesive Trunking	60x16	07
10170 CBR without Dividers		
10500 CBR Trunking	50x20	07
10510 CBR Trunking		
10520 CBR Trunking		
10140 CBR Trunking	75x20	07
10100 CBR Trunking	110x20	05

REFERENCES

CABLE TRUNKING	ACCESSORY
10010 CBR	10011 ABR
10010 FBR	
10020 CBR	10021 ABR
10020 FBR	
10030 CBR	10031 ABR
10030 FBR	
10400 CBR	10401 ABR
10400 FBR	
10410 CBR	
10410 FBR	
10040 CBR	10041 ABR
10040 FBR	
10050 CBR	10051 ABR
10050 FBR	
10150 CBR	
10150 FBR	
10060 CBR	10061 ABR
10060 FBR	
10160 CBR	
10160 FBR	
10070 CBR	10071 ABR
10170 CBR	
10500 CBR	10501 ABR
10510 CBR	
10520 CBR	
10140 CBR	10141 ABR

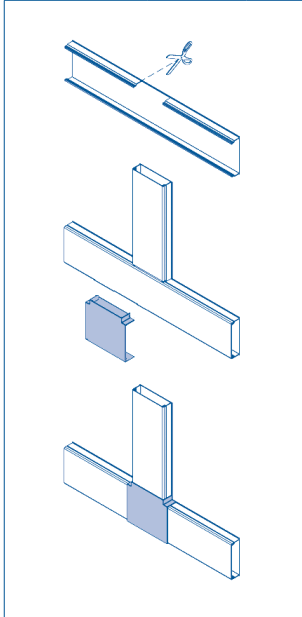

CABLE TRUNKING	ACCESSORY
10010 CBR	10012 ABR
10010 FBR	
10020 CBR	10022 ABR
10020 FBR	
10030 CBR	10032 ABR
10030 FBR	
10400 CBR	10402 ABR
10400 FBR	
10410 CBR	
10410 FBR	
10040 CBR	10042 ABR
10040 FBR	
10050 CBR	10052 ABR
10050 FBR	
10150 CBR	
10150 FBR	
10060 CBR	10062 ABR
10060 FBR	
10160 CBR	
10160 FBR	
10070 CBR	10072 ABR
10170 CBR	
10500 CBR	10502 ABR
10510 CBR	
10520 CBR	
10140 CBR	10142 ABR

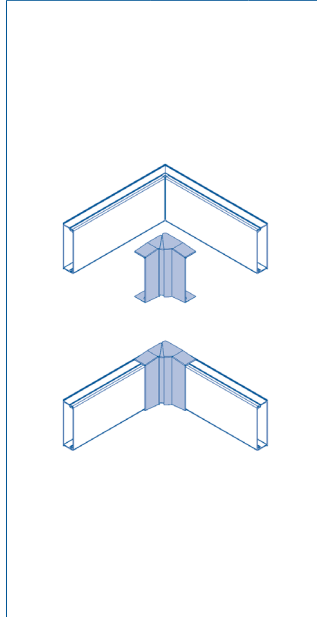

CABLE TRUNKING	ACCESSORY
10010 CBR	10013 ABR
10010 FBR	
10020 CBR	10023 ABR
10020 FBR	
10030 CBR	10033 ABR
10030 FBR	
10400 CBR	10403 ABR
10400 FBR	
10410 CBR	
10410 FBR	
10040 CBR	10043 ABR
10040 FBR	
10050 CBR	10053 ABR
10050 FBR	
10150 CBR	
10150 FBR	
10060 CBR	10063 ABR
10060 FBR	
10160 CBR	
10160 FBR	
10070 CBR	10073 ABR
10170 CBR	
10500 CBR	10503 ABR
10510 CBR	
10520 CBR	
10140 CBR	10143 ABR

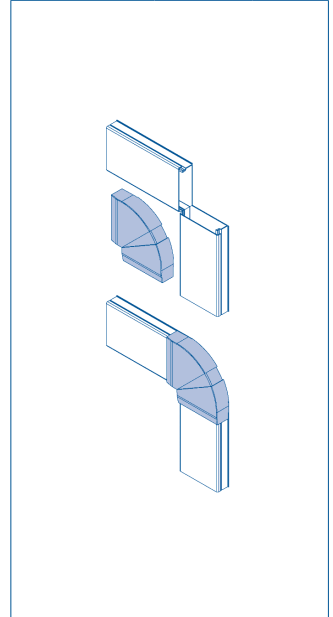

REFERENCES

CABLE TRUNKING	ACCESSORY
10010 CBR	10014 ABR
10010 FBR	
10020 CBR	10024 ABR
10020 FBR	
10030 CBR	10034 ABR
10030 FBR	
10400 CBR	10404 ABR
10400 FBR	
10410 CBR	
10410 FBR	
10040 CBR	10044 ABR
10040 FBR	
10050 CBR	10054 ABR
10050 FBR	
10150 CBR	
10150 FBR	
10060 CBR	10064 ABR
10060 FBR	
10160 CBR	
10160 FBR	
10070 CBR	10074 ABR
10170 CBR	
10500 CBR	10504 ABR
10510 CBR	
10520 CBR	
10140 CBR	10144 ABR

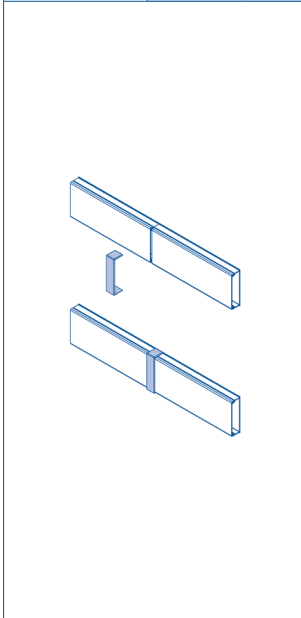

CABLE TRUNKING	ACCESSORY
10010 CBR	10015 ABR
10010 FBR	
10020 CBR	10025 ABR
10020 FBR	
10030 CBR	10035 ABR
10030 FBR	
10400 CBR	10405 ABR
10400 FBR	
10410 CBR	
10410 FBR	
10040 CBR	10045 ABR
10040 FBR	
10050 CBR	10055 ABR
10050 FBR	
10150 CBR	
10150 FBR	
10060 CBR	10065 ABR
10060 FBR	
10160 CBR	
10160 FBR	
10070 CBR	10075 ABR
10170 CBR	
10500 CBR	10505 ABR
10510 CBR	
10520 CBR	
10140 CBR	10145 ABR

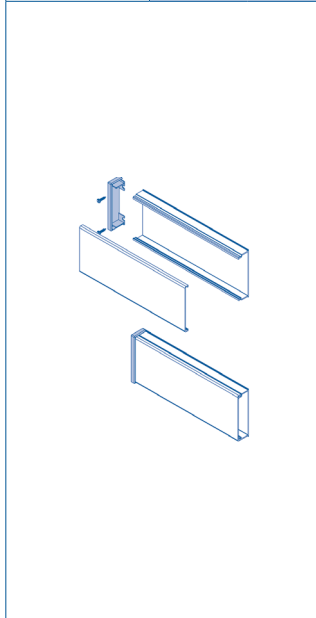

CABLE TRUNKING	ACCESSORY
10010 CBR	10016 ABR
10010 FBR	
10020 CBR	10026 ABR
10020 FBR	
10030 CBR	10036 ABR
10030 FBR	
10400 CBR	10406 ABR
10400 FBR	
10410 CBR	
10410 FBR	
10040 CBR	10046 ABR
10040 FBR	
10050 CBR	10056 ABR
10050 FBR	
10150 CBR	
10150 FBR	
10060 CBR	10066 ABR
10060 FBR	
10160 CBR	
10160 FBR	
10070 CBR	10076 ABR
10170 CBR	
10500 CBR	10506 ABR
10510 CBR	
10520 CBR	
10140 CBR	10146 ABR

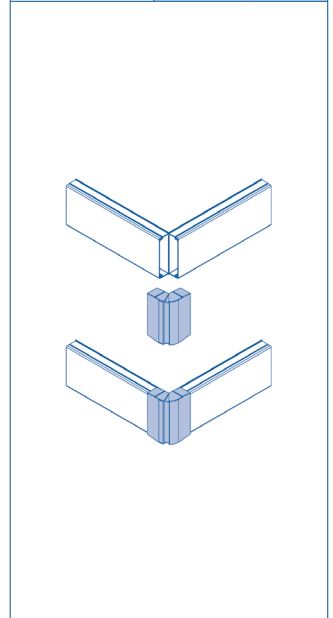

MOUNTING FLUSH MOUNTING DEVICES

LOGUS 90 | SIRIUS 70 | APOLO 5000 SERIES

1. Fix the trunking and the surface mounting box.

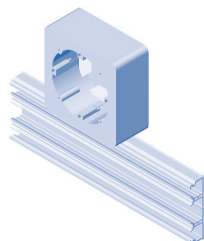

2. Make the connections and mount the mechanism.

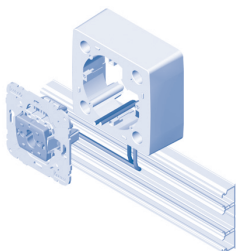

3. Apply the trunking cover, the adapter, the plates and cover plates/rockers.

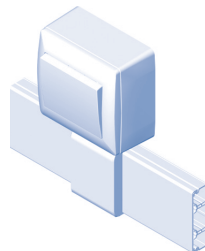

QUADRO 45 SERIES (only with trunkings 60x16 and 75x20)

1. Fix the trunking. After fixing the trunking, apply the q45 series frontal adapter

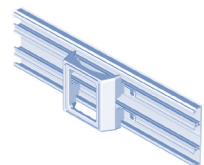

2. Make the connections and mount the mechanism.

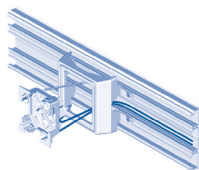

3. Make the connections and mount the mechanism.

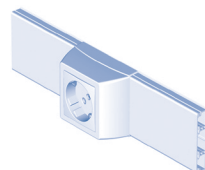

3700 SERIES

1. Fix the trunking. After fixing the trunking, fix the base and the mechanism to the wall.

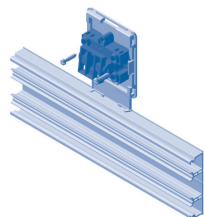

2. Connect.

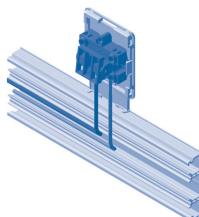

3. The apparatus box, rockers/cover plates, trunking cover and adapter.

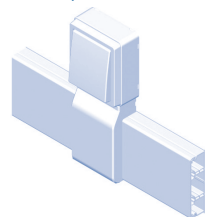

47 SERIES (only with trunkings 60x16 and 75x20)

1. Fix the trunking. Fix the adapter's base and the apparatus to the wall.

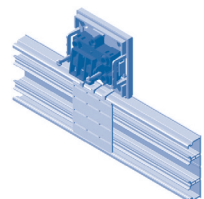

2. Cut the insulator and connect.

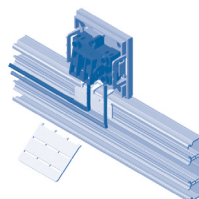

3. Apply the trunking cover, adapter, plates and cover plates/rockers.

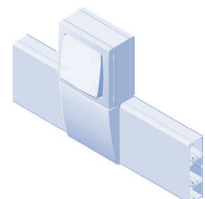

DEDICATED BOXES

SURFACE MOUNTING BOX FOR ITALIAN/AMERICAN TYPE MECHANISMS

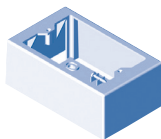

JUNCTION BOX 80X80X20

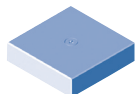

JUNCTION BOX 80X80X30

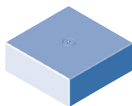

JUNCTION BOX 110x110x50

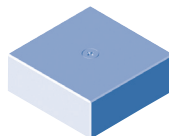

EN 50085-2-1 STANDARD

SECTION 6	CLASSIFICATION	10 SERIES - MINIATURE CABLE TRUNKINGS AND SKIRT CABLE TRUNKINGS	
6.2	Resistance to impact for installation and application	12x7	0,5J
		110x20	1J
		16x10 / 20x12,5 / 32X12,5 / 32x16 / 40x12,5 / 40x16 / 60x16 / 50X20 / 75x20	2J
6.3	Minimum storage and transport temperature	-25°C	
6.3	Minimum installation and application temperature	-5°C	
6.3	Maximum application temperature	60°C	
6.4	Resistance to flame propagation	Non-flame propagating	
6.5	Electrical continuity	Without electrical continuity	
6.6	Electrical insulation characteristic	With electrical insulation	
6.7	Protection degree provided by enclosure	IP44	
6.8	Protection against corrosive or polluting substances	With medium protection outside and inside	
6.9	Access system and retention of the cover	The cover can only be removed with a tool	
6.10	Electrical protective separation	With electrical protective partition (divider)	
6.101	Intended installation positions	Surface mounted fixed on the wall or on the ceiling	
6.102	Prevention of contact between liquids and insulated conductors and live parts in case of mounted in a skirting position and on wet floor.	Not declared	
6.103	Type	3 (Installation)	
	Rated Voltage	500V~	



RoHS - All the Cable Trunkings and the respective Accessories manufactured by EFAPEL fulfil the specifications of the RoHS 2011/65/UE Directive that restricts the use of certain hazardous substances like lead, mercury, cadmium, hexavalent chromium, polybrominated biphenyls (PBB) and polybrominated diphenyl ether (PBDE).

EFAPEL reserves the right to amend this document or the products contained in it without notice. If in doubt please contact EFAPEL.

EFAPEL®

SCHÉMA DE MONTAGE DE ACCESSOIRES

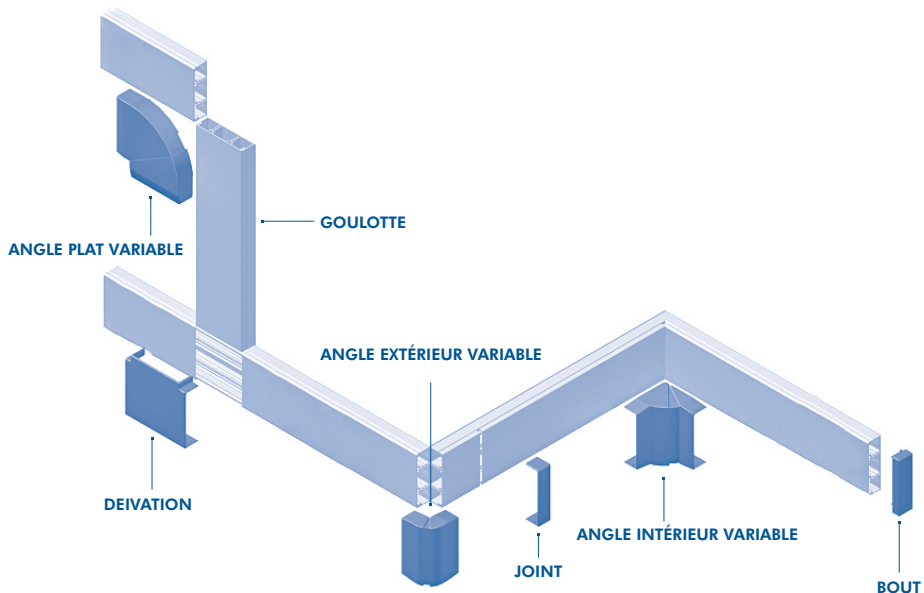

DÉSIGNATION RÉF.	DIMENSIONS EXTÉRIEURES (MM)	PROTECTION CONTRE LES CHOCS MÉCANIQUES EXTERNES - IK
Goulotte 10010 CBR	12x7	05
Goulotte 10010 FBR Adhésive		
Goulotte 10020 CBR	16x10	07
Goulotte 10020 FBR Adhésive		
Goulotte 10030 CBR	20x12,5	07
Goulotte 10030 FBR Adhésive		
Goulotte 10400 CBR	32x12,5	07
Goulotte 10400 FBR Adhésive		
Goulotte 10410 CBR sans Séparateur		
Goulotte 10410 FBR Adhésive sans Séparateur		
Goulotte 10040 CBR	32x16	07
Goulotte 10040 FBR Adhésive		
Goulotte 10050 CBR	40x12,5	07
Goulotte 10050 FBR Adhésive		
Goulotte 10150 CBR sans Séparateur		
Goulotte 10150 FBR Adhésive sans Séparateur		
Goulotte 10060 CBR	40x16	07
Goulotte 10060 FBR Adhésive		
Goulotte 10160 CBR sans Séparateur		
Goulotte 10160 FBR Adhésive sans Séparateur		
Goulotte 10070 CBR	60x16	07
Goulotte 10170 CBR sans Séparateurs		
Goulotte 10500 CBR	50x20	07
Goulotte 10510 CBR		
Goulotte 10520 CBR		
Goulotte 10140 CBR	75x20	07
Goulotte 10100 CBR	110x20	05

RÉFÉRENCES

GOULOTTE	ACCESSOIRES
10010 CBR	10011 ABR
10010 FBR	
10020 CBR	10021 ABR
10020 FBR	
10030 CBR	10031 ABR
10030 FBR	
10400 CBR	10401 ABR
10400 FBR	
10410 CBR	
10410 FBR	
10040 CBR	10041 ABR
10040 FBR	
10050 CBR	10051 ABR
10050 FBR	
10150 CBR	
10150 FBR	
10060 CBR	
10060 FBR	10061 ABR
10160 CBR	
10160 FBR	
10070 CBR	
10170 CBR	
10500 CBR	10501 ABR
10510 CBR	
10520 CBR	
10140 CBR	10141 ABR

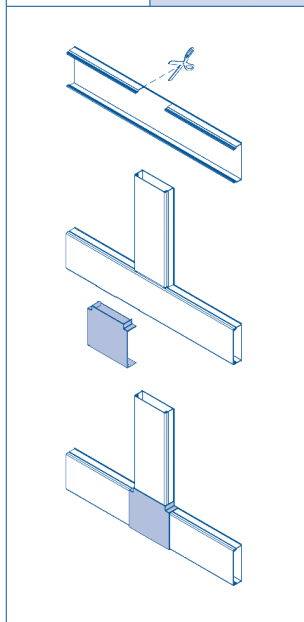

GOULOTTE	ACCESSOIRES
10010 CBR	10012 ABR
10010 FBR	
10020 CBR	10022 ABR
10020 FBR	
10030 CBR	10032 ABR
10030 FBR	
10400 CBR	10402 ABR
10400 FBR	
10410 CBR	
10410 FBR	
10040 CBR	10042 ABR
10040 FBR	
10050 CBR	10052 ABR
10050 FBR	
10150 CBR	
10150 FBR	
10060 CBR	
10060 FBR	
10160 CBR	
10160 FBR	
10070 CBR	10072 ABR
10170 CBR	
10500 CBR	10502 ABR
10510 CBR	
10520 CBR	
10140 CBR	10142 ABR

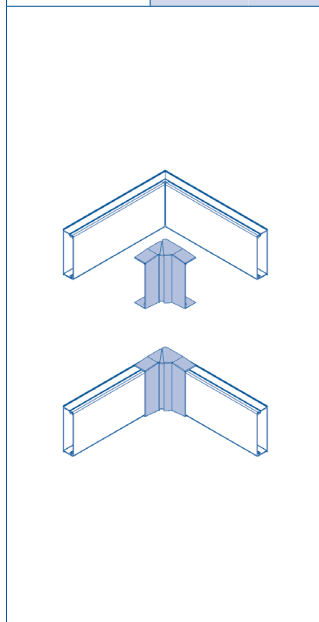

GOULOTTE	ACCESSOIRES
10010 CBR	10013 ABR
10010 FBR	
10020 CBR	10023 ABR
10020 FBR	
10030 CBR	10033 ABR
10030 FBR	
10400 CBR	10403 ABR
10400 FBR	
10410 CBR	
10410 FBR	
10040 CBR	10043 ABR
10040 FBR	
10050 CBR	10053 ABR
10050 FBR	
10150 CBR	
10150 FBR	
10060 CBR	
10060 FBR	
10160 CBR	
10160 FBR	
10070 CBR	10073 ABR
10170 CBR	
10500 CBR	10503 ABR
10510 CBR	
10520 CBR	
10140 CBR	10143 ABR

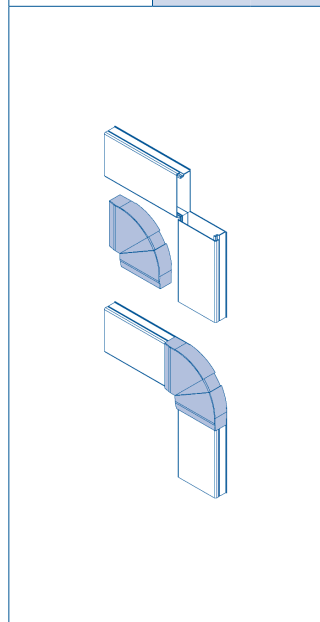

RÉFÉRENCES

GOULOTTE	ACCESSOIRES
10010 CBR	10014 ABR
10010 FBR	
10020 CBR	10024 ABR
10020 FBR	
10030 CBR	10034 ABR
10030 FBR	
10400 CBR	10404 ABR
10400 FBR	
10410 CBR	
10410 FBR	
10040 CBR	10044 ABR
10040 FBR	
10050 CBR	10054 ABR
10050 FBR	
10150 CBR	
10150 FBR	
10060 CBR	
10060 FBR	10064 ABR
10160 CBR	
10160 FBR	
10070 CBR	10074 ABR
10170 CBR	
10500 CBR	10504 ABR
10510 CBR	
10520 CBR	
10140 CBR	10144 ABR



GOULOTTE	ACCESSOIRES
10010 CBR	10015 ABR
10010 FBR	
10020 CBR	10025 ABR
10020 FBR	
10030 CBR	10035 ABR
10030 FBR	
10400 CBR	10405 ABR
10400 FBR	
10410 CBR	
10410 FBR	
10040 CBR	10045 ABR
10040 FBR	
10050 CBR	10055 ABR
10050 FBR	
10150 CBR	
10150 FBR	
10060 CBR	
10060 FBR	10065 ABR
10160 CBR	
10160 FBR	
10070 CBR	10075 ABR
10170 CBR	
10500 CBR	10505 ABR
10510 CBR	
10520 CBR	
10140 CBR	10145 ABR

GOULOTTE	ACCESSOIRES
10010 CBR	10016 ABR
10010 FBR	
10020 CBR	10026 ABR
10020 FBR	
10030 CBR	10036 ABR
10030 FBR	
10400 CBR	10406 ABR
10400 FBR	
10410 CBR	
10410 FBR	
10040 CBR	10046 ABR
10040 FBR	
10050 CBR	10056 ABR
10050 FBR	
10150 CBR	
10150 FBR	
10060 CBR	
10060 FBR	10066 ABR
10160 CBR	
10160 FBR	
10070 CBR	10076 ABR
10170 CBR	
10500 CBR	10506 ABR
10510 CBR	
10520 CBR	
10140 CBR	10146 ABR

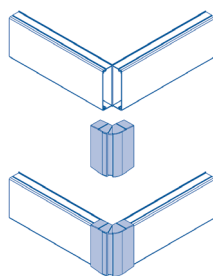
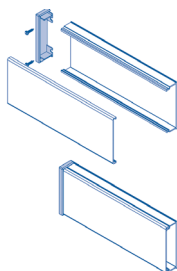
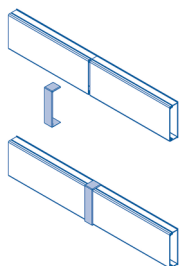

MONTAGE D'APPAREILLAGE

SÉRIE LOGUS 90 | SIRIUS 70 | APOLO 5000

1. Fixer la goulotte et la boîte saillie.

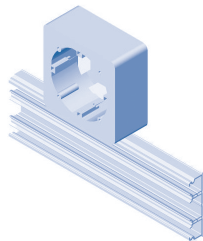

2. Connecter et monter le mécanisme.

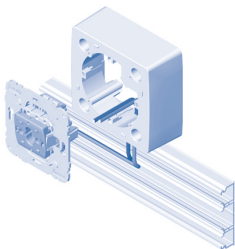

3. Appliquer le couvercle de la goulotte, l'adaptateur, les plaques et les enjoliveurs/doigts.

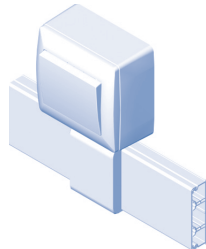

SÉRIE QUADRO 45 (seulement avec goulottes 60x16 et 75x20)

1. Fixer la goulotte. Après avoir fixé la goulotte, appliquer l'adaptateur frontal de la série Q45.

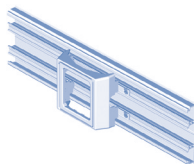

2. Connecter et monter le mécanisme.

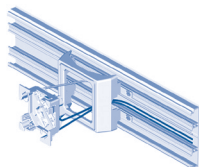

3. Appliquer le couvercle de la goulotte et les doigts.

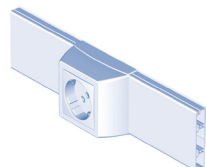

SÉRIE 3700

1. Fixer la goulotte. Après avoir fixé la goulotte, fixer la base et le mécanisme au mur.

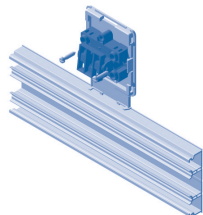

2. Connecter.

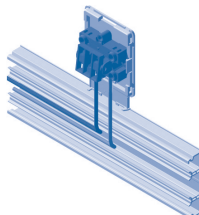

3. Appliquer la boîte de l'appareil, doigts/enjoliveurs, le couvercle de la goulotte et l'adaptateur.

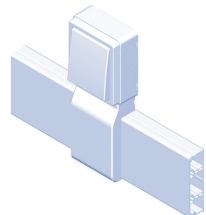

SÉRIE 47 (seulement avec goulottes 60x16 et 75x20)

1. Fixer la goulotte. Fixer la base de l'adaptateur et l'appareil au mur.

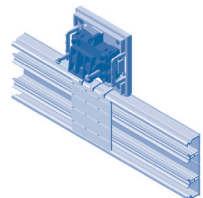

2. Couper l'isolateur et connecter.

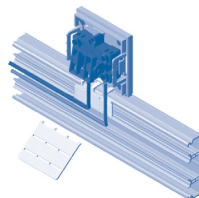

3. Appliquer le couvercle de la goulotte, l'adaptateur, les plaques et les enjoliveurs/doigts.

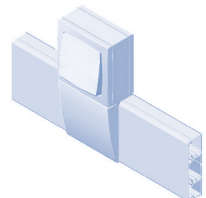

BOÎTES DÉDIÉES

BOÎTE SAILLIE POUR MÉCANISMES DU TYPE ITALIEN

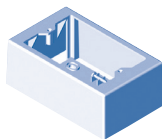

BOÎTE DE DÉRIVATION 80x80x20



BOÎTE DE DÉRIVATION 80x80x30



BOÎTE DE DÉRIVATION 110x110x50

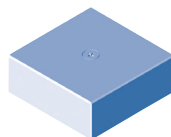

NORME EN 50085-2-1

SECTION 6	CLASSIFICATION	SÉRIE 10 - MOULURES ET PLINTHES	
6.2	Résistance aux chocs pendant l'installation et l'usage	12x7	0,5J
		110x20	1J
		16x10 / 20x12,5 / 32x12,5 / 32x16 / 40x12,5 / 40x16 / 60x16 / 50x20 / 75x20	2J
6.3	Température minimale de stockage et de transport	-25°C	
6.3	Température minimale d'installation et d'usage	-5°C	
6.3	Température maximale d'usage	60°C	
6.4	Résistance à la propagation de la flamme	Non propagation de la flamme	
6.5	Continuité électrique	Sans continuité électrique	
6.6	Caractéristiques d'isolation électrique	Avec isolation électrique	
6.7	Degré de protection de l'enveloppe	IP44	
6.8	Protection contre les substances corrosives ou polluantes	Avec protection moyenne à l'extérieur et l'intérieur	
6.9	Mode d'ouverture	Le couvercle peut être enlevé avec un outil	
6.10	Séparation de protection électrique	Avec séparation de protection électrique (séparateur)	
6.101	Conditions d'installation	Saillie fixé au mur ou au plafond	
6.102	Prévention de contact entre les liquides, les conducteurs isolés et les parties sous tension, dans le cas de goulottes de plinthe en plancher humide.	Non déclarée	
6.103	Type	3 (Installation)	
	Tension Nominale Assignée	500V~	



RoHS - Toutes les Goulottes et respectifs Accessoires EFAPEL sont conformes avec la Directive RoHS 2011/65/UE qui restreint l'utilisation de certaines substances dangereuses comme le plomb, le mercure, le cadmium, le chrome hexavalent, les polybromobiphényles (PBB) et les polybromodiphényléthers (PBDE).

EFAPEL se réserve le droit de modifier ce document ou les produits ci-inclus sans préavis. En cas de doute, veuillez contacter EFAPEL.

EFAPEL[®]

ESQUEMA DE MONTAJE DE ACCESORIOS

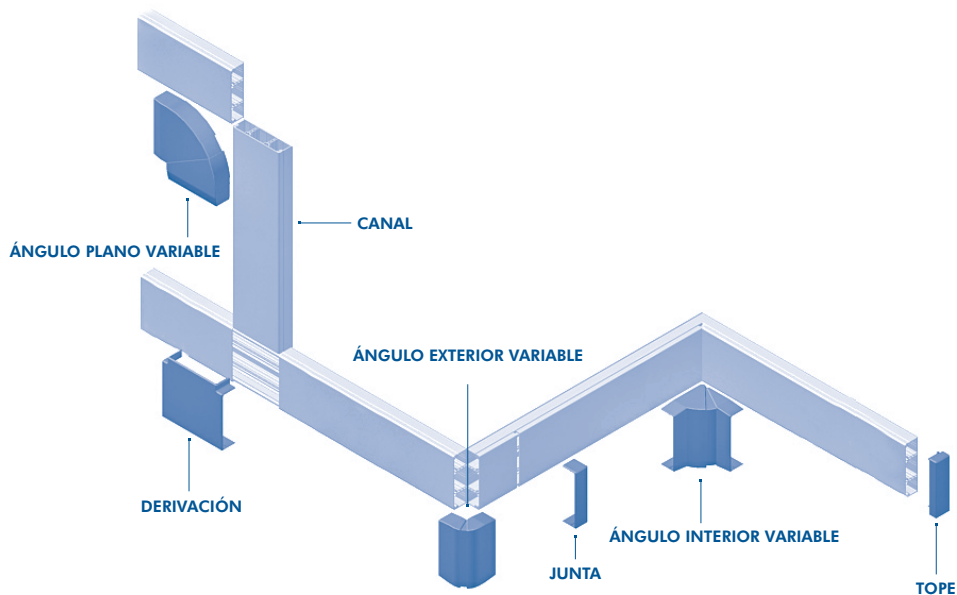

DESIGNACIÓN REF.º	MEDIDAS EXTERIORES(MM)	PROTECCIÓN CONTRA IMPACTOS MECÁNICOS EXTERNOS - IK
Canal 10010 CBR	12x7	05
Canal 10010 FBR con Cinta Autoadhesiva		
Canal 10020 CBR	16x10	07
Canal 10020 FBR con Cinta Autoadhesiva		
Canal 10030 CBR	20x12,5	07
Canal 10030 FBR con Cinta Autoadhesiva		
Canal 10400 CBR	32x12,5	07
Canal 10400 FBR con Cinta Autoadhesiva		
Canal 10410 CBR sin División		
Canal 10410 FBR sin División con Cinta Autoadhesiva		
Canal 10040 CBR	32x16	07
Canal 10040 FBR con Cinta Autoadhesiva		
Canal 10050 CBR	40x12,5	07
Canal 10050 FBR con Cinta Autoadhesiva		
Canal 10150 CBR sin División		
Canal 10150 FBR sin División con Cinta Autoadhesiva	40x16	07
Canal 10060 CBR		
Canal 10060 FBR con Cinta Autoadhesiva		
Canal 10160 CBR sin División		
Canal 10160 FBR sin División con Cinta Autoadhesiva	60x16	07
Canal 10070 CBR		
Canal 10170 CBR sin Divisiones	50x20	07
Canal 10500 CBR		
Canal 10510 CBR		
Canal 10520 CBR	75x20	07
Canal 10140 CBR		
Canal 10100 CBR	110x20	05

REFERENCIAS

CANAL	ACCESORIOS
10010 CBR	10011 ABR
10010 FBR	
10020 CBR	10021 ABR
10020 FBR	
10030 CBR	10031 ABR
10030 FBR	
10400 CBR	10401 ABR
10400 FBR	
10410 CBR	
10410 FBR	
10040 CBR	10041 ABR
10040 FBR	
10050 CBR	10051 ABR
10050 FBR	
10150 CBR	
10150 FBR	
10060 CBR	
10060 FBR	10061 ABR
10160 CBR	
10160 FBR	
10070 CBR	
10170 CBR	
10500 CBR	10501 ABR
10510 CBR	
10520 CBR	
10140 CBR	10141 ABR

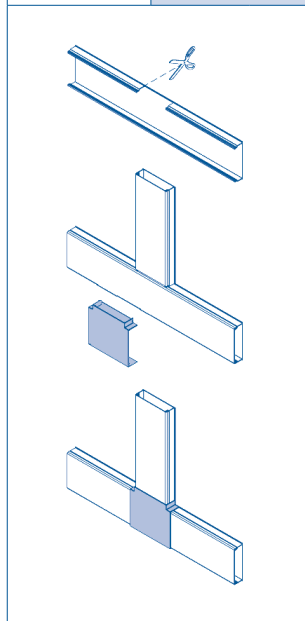

CANAL	ACCESORIOS
10010 CBR	10012 ABR
10010 FBR	
10020 CBR	10022 ABR
10020 FBR	
10030 CBR	10032 ABR
10030 FBR	
10400 CBR	10402 ABR
10400 FBR	
10410 CBR	
10410 FBR	
10040 CBR	10042 ABR
10040 FBR	
10050 CBR	10052 ABR
10050 FBR	
10150 CBR	
10150 FBR	
10060 CBR	
10060 FBR	
10160 CBR	
10160 FBR	
10070 CBR	10072 ABR
10170 CBR	
10500 CBR	10502 ABR
10510 CBR	
10520 CBR	
10140 CBR	10142 ABR

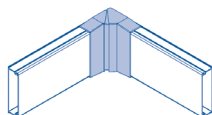
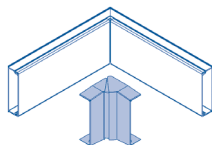

CANAL	ACCESORIOS
10010 CBR	10013 ABR
10010 FBR	
10020 CBR	10023 ABR
10020 FBR	
10030 CBR	10033 ABR
10030 FBR	
10400 CBR	10403 ABR
10400 FBR	
10410 CBR	
10410 FBR	
10040 CBR	10043 ABR
10040 FBR	
10050 CBR	10053 ABR
10050 FBR	
10150 CBR	
10150 FBR	
10060 CBR	
10060 FBR	
10160 CBR	
10160 FBR	
10070 CBR	10073 ABR
10170 CBR	
10500 CBR	10503 ABR
10510 CBR	
10520 CBR	
10140 CBR	10143 ABR

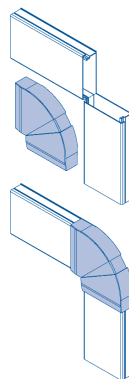

REFERENCIAS

CANAL	ACCESORIOS
10010 CBR	10014 ABR
10010 FBR	
10020 CBR	10024 ABR
10020 FBR	
10030 CBR	10034 ABR
10030 FBR	
10400 CBR	10404 ABR
10400 FBR	
10410 CBR	
10410 FBR	
10040 CBR	10044 ABR
10040 FBR	
10050 CBR	10054 ABR
10050 FBR	
10150 CBR	
10150 FBR	
10060 CBR	
10060 FBR	10064 ABR
10160 CBR	
10160 FBR	
10070 CBR	10074 ABR
10170 CBR	
10500 CBR	10504 ABR
10510 CBR	
10520 CBR	
10140 CBR	10144 ABR



CANAL	ACCESORIOS
10010 CBR	10015 ABR
10010 FBR	
10020 CBR	10025 ABR
10020 FBR	
10030 CBR	10035 ABR
10030 FBR	
10400 CBR	10405 ABR
10400 FBR	
10410 CBR	
10410 FBR	
10040 CBR	10045 ABR
10040 FBR	
10050 CBR	10055 ABR
10050 FBR	
10150 CBR	
10150 FBR	
10060 CBR	
10060 FBR	10065 ABR
10160 CBR	
10160 FBR	
10070 CBR	10075 ABR
10170 CBR	
10500 CBR	10505 ABR
10510 CBR	
10520 CBR	
10140 CBR	10145 ABR

CANAL	ACCESORIOS
10010 CBR	10016 ABR
10010 FBR	
10020 CBR	10026 ABR
10020 FBR	
10030 CBR	10036 ABR
10030 FBR	
10400 CBR	10406 ABR
10400 FBR	
10410 CBR	
10410 FBR	
10040 CBR	10046 ABR
10040 FBR	
10050 CBR	10056 ABR
10050 FBR	
10150 CBR	
10150 FBR	
10060 CBR	
10060 FBR	10066 ABR
10160 CBR	
10160 FBR	
10070 CBR	10076 ABR
10170 CBR	
10500 CBR	10506 ABR
10510 CBR	
10520 CBR	
10140 CBR	10146 ABR

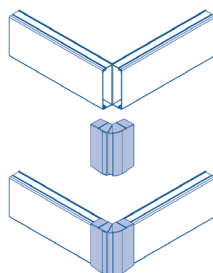
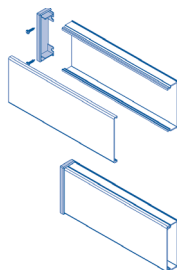
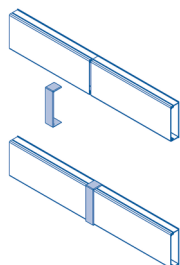

MONTAJE DE MECANISMOS

SERIE LOGUS 90 | SIRIUS 70 | APOLO 5000

1. Fijar el canal y la caja saliente.

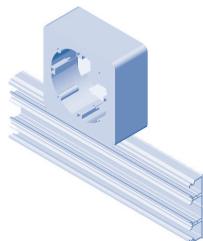

2. Hacer las conexiones y montar el mecanismo.

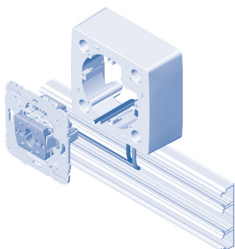

3. Aplicar la tapa del canal, el adaptador, los marcos y tapas/teclas.

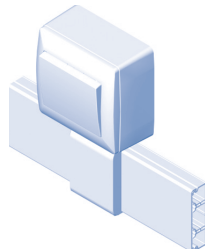

SERIE QUADRO 45 (solamente con canales 60x16 y 75x20)

1. Fijar el canal. Después de fijar el canal, aplicar el adaptador frontal serie Q45.

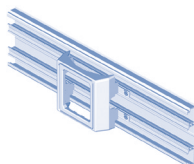

2. Hacer las conexiones y montar el mecanismo.

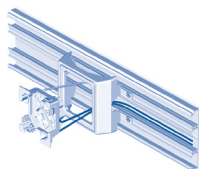

3. Aplicar la tapa del canal y las tapas.

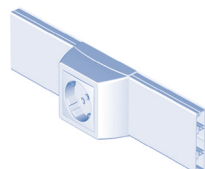

SERIE 3700

1. Fijar el canal. Después de fijar el canal, fijar la base y el mecanismo a la pared.

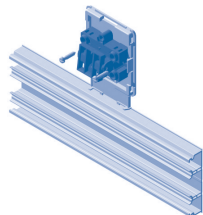

2. Hacer las conexiones.

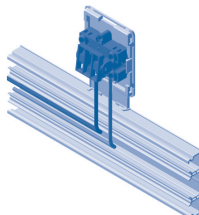

3. Aplicar la caja del aparato, teclas/tapas, la tapa del canal y el adaptador.

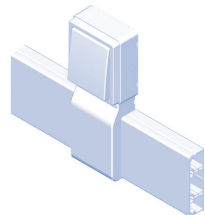

SERIE 47 (solamente con canales 60x16 y 75x20)

1. Fijar el canal. Fijar la base del adaptador y el aparato a la pared.

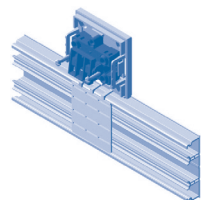

2. Cortar el aislador y hacer las conexiones.

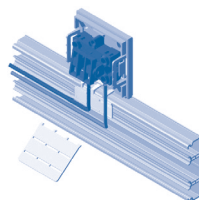

3. Aplicar la tapa del canal, el adaptador, los marcos y tapas/teclas.

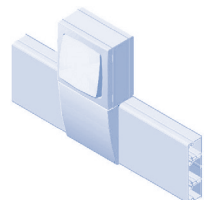

CAJA SALIENTE PARA APARELLAJE TIPO ITALIANO

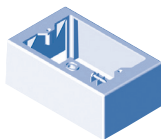

CAJA DE DERIVACIÓN 80x80x20

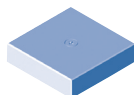

CAJA DE DERIVACIÓN 80x80x30

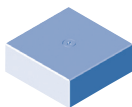

CAJA DE DERIVACIÓN 110x110x50

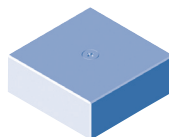

NORMA EN 50085-2-1

SECCIÓN 6	CLASIFICACIÓN	SERIE10 - MOLDURAS Y CANALES DE ZOCÁLO	
6.2	Resistencia al impacto durante la instalación y uso	12x7	0,5J
		110x20	1J
		16x10 / 20x12,5 / 32x12,5 / 32x16 / 40x12,5 / 40x16 / 60x16 / 50x20 / 75x20	2J
6.3	Temperatura mínima de transporte y almacenamiento	-25°C	
6.3	Temperatura mínima de instalación y de uso	-5°C	
6.3	Temperatura máxima de utilización	60°C	
6.4	Resistencia a la propagación de la llama	No propagador de la llama	
6.5	Continuidad eléctrica	Sin continuidad eléctrica	
6.6	Características de aislación eléctrica	Con aislamiento eléctrico	
6.7	Grado de protección dado por envoltura	IP44	
6.8	Protección contra sustancias corrosivas o poluentes	Medianamente protegidos en el exterior y en el interior	
6.9	Sistema de acceso y retención de la tapa	La tapa sólo puede ser abierta con una herramienta	
6.10	Separación y protección eléctrica	Con separadores de protección eléctrica (divisiones)	
6.101	Posiciones de instalación previstas	Montaje superficial en paredes o en techos	
6.102	Prevención del contacto entre líquidos y conductores aislados y partes activas para el caso de canales montados en zócalos o en el suelo humedecido con productos químicos.	No declarado	
6.103	Tipo	3 (Instalación)	
	Tensión Nominal	500V~	



RoHS - Todos los Canales y sus respectivos Accesorios fabricados por EFAPEL satisfacen las especificaciones de la Directiva RoHS 2011/65/UE que restringe la utilización de sustancias o compuestos peligrosos como el Plomo, Mercurio, Cadmio, Cromo hexavalente, Polibromobifenilos (PBB) o Polibromodifeniléteres (PBDE).

EFAPEL se reserva el derecho de modificar este documento o los productos contenidos en él sin previo aviso. En caso de dudas, por favor póngase en contacto con EFAPEL.

EINBAUPLAN FÜR ZUBEHÖR

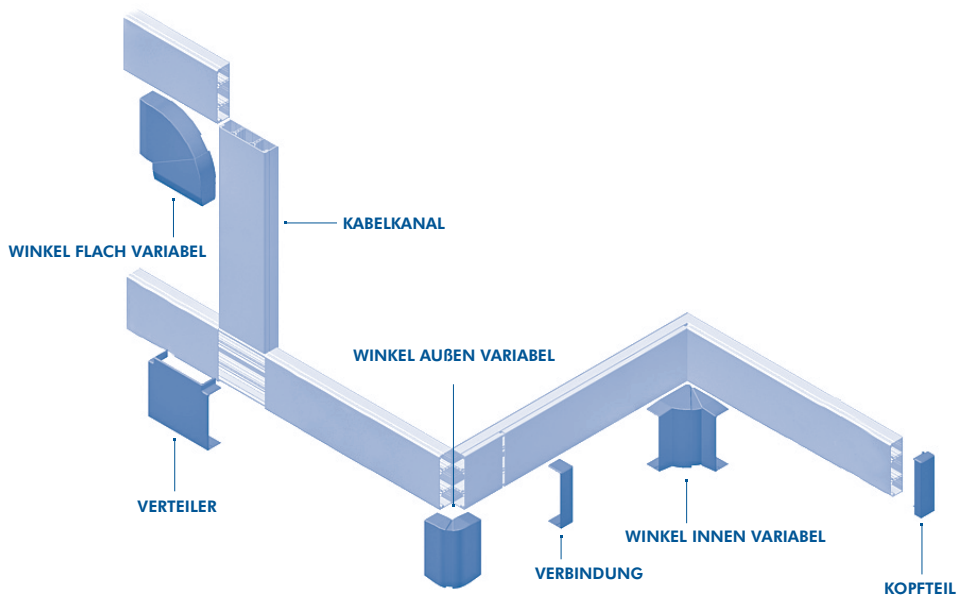

BEZEICHNUNG REF.-NR.	AUBENMAßE (MM)	SCHUTZ GEGEN MECHANISCHE EINWIRKUNG VON AUSSEN IK
Kabelkanal 10010 CBR	12x7	05
Kabelkanal 10010 FBR Selbstklebend		
Kabelkanal 10020 CBR	16x10	07
Kabelkanal 10020 FBR Selbstklebend		
Kabelkanal 10030 CBR	20x12,5	07
Kabelkanal 10030 FBR Selbstklebend		
Kabelkanal 10400 CBR	32x12,5	07
Kabelkanal 10400 FBR Selbstklebend		
Kabelkanal 10410 CBR ohne Unterteilung		
Kabelkanal 10410 FBR ohne Unterteilung, Selbstklebend		
Kabelkanal 10040 CBR	32x16	07
Kabelkanal 10040 FBR Selbstklebend		
Kabelkanal 10050 CBR	40x12,5	07
Kabelkanal 10050 FBR Selbstklebend		
Kabelkanal 10150 CBR ohne Unterteilung		
Kabelkanal 10150 FBR ohne Unterteilung, Selbstklebend	40x16	07
Kabelkanal 10060 CBR		
Kabelkanal 10060 FBR Selbstklebend		
Kabelkanal 10160 CBR ohne Unterteilung		
Kabelkanal 10160 FBR ohne Unterteilung, Selbstklebend	60x16	07
Kabelkanal 10070 CBR		
Kabelkanal 10170 CBR ohne Unterteilungen	50x20	07
Kabelkanal 10500 CBR		
Kabelkanal 10510 CBR		
Kabelkanal 10520 CBR	75x20	07
Kabelkanal 10140 CBR		
Kabelkanal 10100 CBR	110x20	05

REFERENZ

KABELKANAL	ZUBEHÖR
10010 CBR	10011 ABR
10010 FBR	
10020 CBR	10021 ABR
10020 FBR	
10030 CBR	10031 ABR
10030 FBR	
10400 CBR	10401 ABR
10400 FBR	
10410 CBR	
10410 FBR	
10040 CBR	10041 ABR
10040 FBR	
10050 CBR	10051 ABR
10050 FBR	
10150 CBR	
10150 FBR	
10060 CBR	10061 ABR
10060 FBR	
10160 CBR	
10160 FBR	
10070 CBR	10071 ABR
10170 CBR	
10500 CBR	10501 ABR
10510 CBR	
10520 CBR	
10140 CBR	10141 ABR

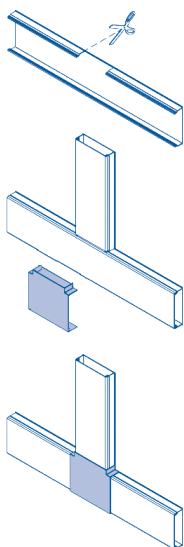

KABELKANAL	ZUBEHÖR
10010 CBR	10012 ABR
10010 FBR	
10020 CBR	10022 ABR
10020 FBR	
10030 CBR	10032 ABR
10030 FBR	
10400 CBR	10402 ABR
10400 FBR	
10410 CBR	
10410 FBR	
10040 CBR	10042 ABR
10040 FBR	
10050 CBR	10052 ABR
10050 FBR	
10150 CBR	
10150 FBR	
10060 CBR	10062 ABR
10060 FBR	
10160 CBR	
10160 FBR	
10070 CBR	10072 ABR
10170 CBR	
10500 CBR	10502 ABR
10510 CBR	
10520 CBR	
10140 CBR	10142 ABR

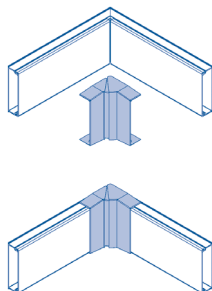

KABELKANAL	ZUBEHÖR
10010 CBR	10013 ABR
10010 FBR	
10020 CBR	10023 ABR
10020 FBR	
10030 CBR	10033 ABR
10030 FBR	
10400 CBR	10403 ABR
10400 FBR	
10410 CBR	
10410 FBR	
10040 CBR	10043 ABR
10040 FBR	
10050 CBR	10053 ABR
10050 FBR	
10150 CBR	
10150 FBR	
10060 CBR	10063 ABR
10060 FBR	
10160 CBR	
10160 FBR	
10070 CBR	10073 ABR
10170 CBR	
10500 CBR	10503 ABR
10510 CBR	
10520 CBR	
10140 CBR	10143 ABR

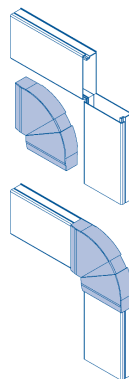

REFERENZ

KABELKANAL	ZUBEHÖR
10010 CBR	10014 ABR
10010 FBR	
10020 CBR	10024 ABR
10020 FBR	
10030 CBR	10034 ABR
10030 FBR	
10400 CBR	10404 ABR
10400 FBR	
10410 CBR	
10410 FBR	
10040 CBR	10044 ABR
10040 FBR	
10050 CBR	10054 ABR
10050 FBR	
10150 CBR	
10150 FBR	
10060 CBR	10064 ABR
10060 FBR	
10160 CBR	
10160 FBR	
10070 CBR	10074 ABR
10170 CBR	
10500 CBR	10504 ABR
10510 CBR	
10520 CBR	
10140 CBR	10144 ABR

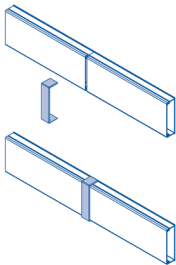

KABELKANAL	ZUBEHÖR
10010 CBR	10015 ABR
10010 FBR	
10020 CBR	10025 ABR
10020 FBR	
10030 CBR	10035 ABR
10030 FBR	
10400 CBR	10405 ABR
10400 FBR	
10410 CBR	
10410 FBR	
10040 CBR	10045 ABR
10040 FBR	
10050 CBR	10055 ABR
10050 FBR	
10150 CBR	
10150 FBR	
10060 CBR	10065 ABR
10060 FBR	
10160 CBR	
10160 FBR	
10070 CBR	10075 ABR
10170 CBR	
10500 CBR	10505 ABR
10510 CBR	
10520 CBR	
10140 CBR	10145 ABR

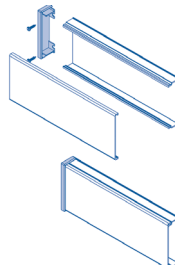

KABELKANAL	ZUBEHÖR
10010 CBR	10016 ABR
10010 FBR	
10020 CBR	10026 ABR
10020 FBR	
10030 CBR	10036 ABR
10030 FBR	
10400 CBR	10406 ABR
10400 FBR	
10410 CBR	
10410 FBR	
10040 CBR	10046 ABR
10040 FBR	
10050 CBR	10056 ABR
10050 FBR	
10150 CBR	
10150 FBR	
10060 CBR	10066 ABR
10060 FBR	
10160 CBR	
10160 FBR	
10070 CBR	10076 ABR
10170 CBR	
10500 CBR	10506 ABR
10510 CBR	
10520 CBR	
10140 CBR	10146 ABR

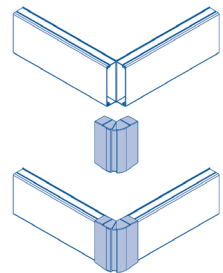

GERÄTEMONTAGE

MODELLREIHE LOGUS 90 | SIRIUS 70 | APOLO 5000

1. Kanal und auptzdose befestigen.

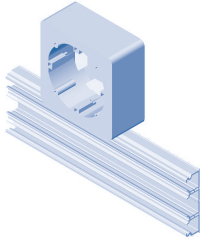

2. Anschlüsse verbinden und

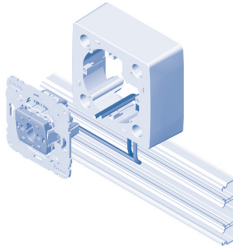

3. Kanalabdeckung, adapter, rahmen und wippen/abdeckungen montieren.

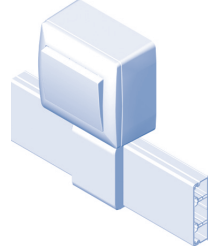

MODELLREIHE QUADRO 45 (nur bei 60x16 und 75x20 kanal)

1. Kanal befestigen. Unterteil des adaptors und gerät an wand befestigen.

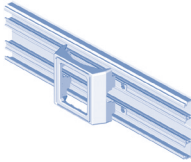

2. Isolator abschneiden und

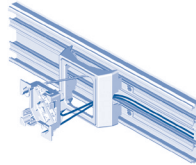

3. Kanalabdeckung, adapter, rahmen und wippen/abdeckungen montieren.

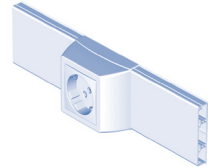

MODELLREIHE 3700

1. Kanal befestigen. Anschließend unterteil des adaptors und vorrichtung an wand befestigen.

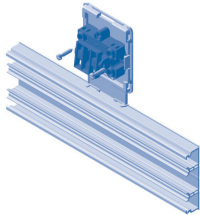

2. Anschlüsse verbinden.

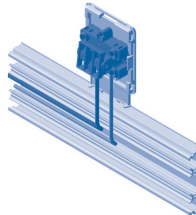

3. Dose des geräts, wippen/abdeckungen, kanalabdeckung und adapter aufsetzen.

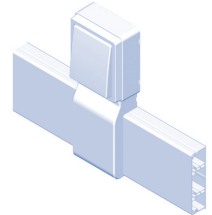

MODELLREIHE 47 (nur bei 60x16 und 75x20 kanal)

1. Kanal befestigen. Unterteil des adaptors und gerät an wand befestigen.

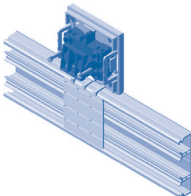

2. Isolator abschneiden und

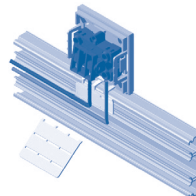

3. Kanalabdeckung, adapter, steckdoseneinsatz und wippen/abdeckungen montieren.

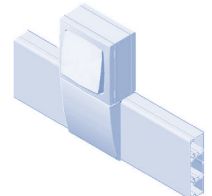

AUFPUTZDOSE FÜR GERÄTE ITALIENISCHER TYP

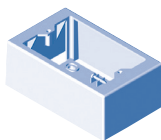

VERTEILERDOSE 80x80x20

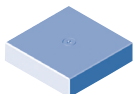

VERTEILERDOSE 80x80x30



VERTEILERDOSE 110x110x50

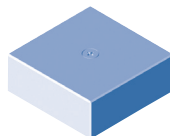

NORM EN 50085-2-1

SEKTION 6	KLASSIFIKATION	MODELLREIHE 10 - RAHMUNGEN UND FUBLEISTEN	
6.2	Prüfung zur Stoßfestigkeit bei Einbau und Anwendung	12x7	0,5J
		110x20	1J
		16x10 / 20x12,5 / 32x12,5 / 32x16 / 40x12,5 / 40x16 / 60x16 / 50x20 / 75x20	2J
6.3	Mindesttemperatur für lager und transport	-25°C	
6.3	Mindesttemperatur für installation und nutzung	-5°C	
6.3	Höchsttemperatur für nutzung	60°C	
6.4	Flammenweiterleitung	Keine flammenweiterleitung	
6.5	Elektrische Kontinuität	Keine elektrische Kontinuität	
6.6	Elektrische Isolierung	Mit elektrischer Isolierung	
6.7	Durch Gehäuse sichergestellte Schutzklasse	IP44	
6.8	Schutz gegen korrodierende Substanzen oder Schadstoffe	Mit mittlerem Schutz, innen und außen	
6.9	Zugangsmöglichkeit der Abdeckungsuhaltung	Die Abdeckung kann nur mit Werkzeug entfernt werden	
6.10	Separierung elektrischer Leiter	Mit Separierung elektrischer Leiter (Unterteilung)	
6.101	Vorgesehene Einbaupositionen	Aufputz, fest an Wand oder Decke	
6.102	Verhinderung des Kontakts zwischen Flüssigkeiten und isolierten Leitern und unter Strom stehenden Teilen in als Bodenleisten montierten Kabelkanälen bei nassem Boden.	Nicht erklärt	
6.103	Typ	3 (Installation)	
	Angegebene Nennspannung	500V~	



RoHS - Sämtliche EFAPEL Kabelkanäle und Zubehör entsprechen der RoHS-Richtlinie 2011/65/EU, die Benutzung von gefährlichen Substanzen oder Zubereitungen einschränkt, die Blei, Quecksilber, Cadmium, Sechswertiges Chrom, Polybromierte Biphenyle (PBB) und/oder Polybromierte Diphenylether (PBDE) enthalten.

Die Firma EFAPEL behält sich das Recht vor, das vorliegende Dokument und die darin enthaltenen Artikel zu ändern. Bei Fragen wenden Sie sich bitte direkt an EFAPEL.

ДЕМОНТАЖ МОДУЛЬНОГО СУППОРТА

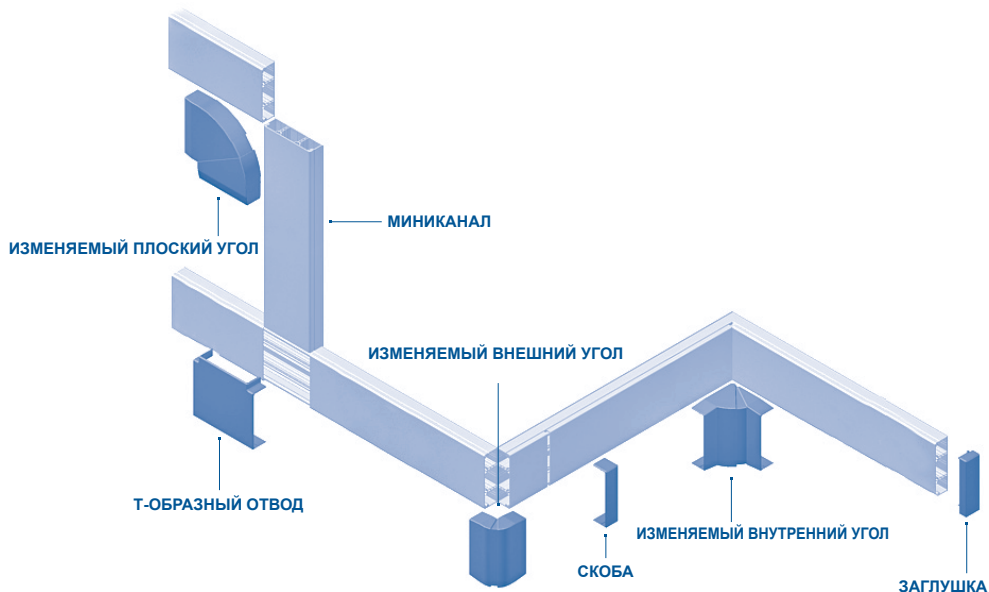

ОБОЗНАЧЕНИЕ КОД	ВНЕШНИЕ РАЗМЕРЫ	СТЕПЕНЬ ЗАЩИТЫ ОТ МЕХАНИЧЕСКИХ ВОЗДЕЙСТВИЙ - ИК
МИНИКАНАЛ 10010 CBR	12x7	05
МИНИКАНАЛ 10010 FBR С САМОКЛЕЮЩЕЙСЯ ОСНОВОЙ		
МИНИКАНАЛ 10020 CBR	16x10	07
МИНИКАНАЛ 10020 FBR С САМОКЛЕЮЩЕЙСЯ ОСНОВОЙ		
МИНИКАНАЛ 10030 CBR	20x12,5	07
МИНИКАНАЛ 10030 FBR С САМОКЛЕЮЩЕЙСЯ ОСНОВОЙ		
МИНИКАНАЛ 10400 CBR	32x12,5	07
МИНИКАНАЛ 10400 FBR С САМОКЛЕЮЩЕЙСЯ ОСНОВОЙ		
МИНИКАНАЛ 10410 CBR БЕЗ ПЕРЕГОРОДКИ		
МИНИКАНАЛ 10410 FBR БЕЗ ПЕРЕГОРОДКИ С САМОКЛЕЮЩЕЙСЯ ОСНОВОЙ		
МИНИКАНАЛ 10040 CBR	32x16	07
МИНИКАНАЛ 10040 FBR С САМОКЛЕЮЩЕЙСЯ ОСНОВОЙ		
МИНИКАНАЛ 10050 CBR	40x12,5	07
МИНИКАНАЛ 10050 FBR С САМОКЛЕЮЩЕЙСЯ ОСНОВОЙ		
МИНИКАНАЛ 10150 CBR БЕЗ ПЕРЕГОРОДКИ		
МИНИКАНАЛ 10150 FBR БЕЗ ПЕРЕГОРОДКИ С САМОКЛЕЮЩЕЙСЯ ОСНОВОЙ	40x16	07
МИНИКАНАЛ 10060 CBR		
МИНИКАНАЛ 10060 FBR С САМОКЛЕЮЩЕЙСЯ ОСНОВОЙ		
МИНИКАНАЛ 10160 CBR БЕЗ ПЕРЕГОРОДКИ		
МИНИКАНАЛ 10160 FBR БЕЗ ПЕРЕГОРОДКИ С САМОКЛЕЮЩЕЙСЯ ОСНОВОЙ	60x16	07
МИНИКАНАЛ 10070 CBR		
МИНИКАНАЛ 10170 CBR БЕЗ ПЕРЕГОРОДКИ	50x20	07
МИНИКАНАЛ 10500 CBR		
МИНИКАНАЛ 10510 CBR		
МИНИКАНАЛ 10520 CBR	75x20	07
МИНИКАНАЛ 10140 CBR		
МИНИКАНАЛ 10100 CBR	110x20	05

АРТИКУЛ ИЛИ КОД ТОВАРА

МИНИКАНАЛ	АКСЕССУАР
10010 CBR	10011 ABR
10010 FBR	
10020 CBR	10021 ABR
10020 FBR	
10030 CBR	10031 ABR
10030 FBR	
10400 CBR	10401 ABR
10400 FBR	
10410 CBR	
10410 FBR	
10040 CBR	10041 ABR
10040 FBR	
10050 CBR	10051 ABR
10050 FBR	
10150 CBR	
10150 FBR	
10060 CBR	10061 ABR
10060 FBR	
10160 CBR	
10160 FBR	
10070 CBR	10071 ABR
10170 CBR	
10500 CBR	10501 ABR
10510 CBR	
10520 CBR	
10140 CBR	10141 ABR

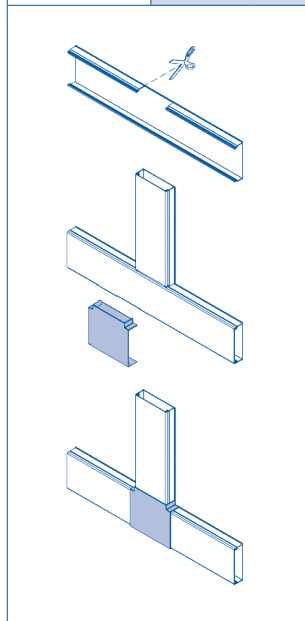

МИНИКАНАЛ	АКСЕССУАР
10010 CBR	10012 ABR
10010 FBR	
10020 CBR	10022 ABR
10020 FBR	
10030 CBR	10032 ABR
10030 FBR	
10400 CBR	10402 ABR
10400 FBR	
10410 CBR	
10410 FBR	
10040 CBR	10042 ABR
10040 FBR	
10050 CBR	10052 ABR
10050 FBR	
10150 CBR	
10150 FBR	
10060 CBR	10062 ABR
10060 FBR	
10160 CBR	
10160 FBR	
10070 CBR	10072 ABR
10170 CBR	
10500 CBR	10502 ABR
10510 CBR	
10520 CBR	
10140 CBR	10142 ABR

МИНИКАНАЛ	АКСЕССУАР
10010 CBR	10013 ABR
10010 FBR	
10020 CBR	10023 ABR
10020 FBR	
10030 CBR	10033 ABR
10030 FBR	
10400 CBR	10403 ABR
10400 FBR	
10410 CBR	
10410 FBR	
10040 CBR	10043 ABR
10040 FBR	
10050 CBR	10053 ABR
10050 FBR	
10150 CBR	
10150 FBR	
10060 CBR	10063 ABR
10060 FBR	
10160 CBR	
10160 FBR	
10070 CBR	10073 ABR
10170 CBR	
10500 CBR	10503 ABR
10510 CBR	
10520 CBR	
10140 CBR	10143 ABR

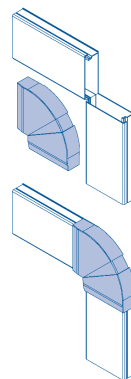

АРТИКУЛ ИЛИ КОД ТОВАРА

МИНИКАНАЛ	АКСЕССУАР
10010 CBR	10014 ABR
10010 FBR	
10020 CBR	10024 ABR
10020 FBR	
10030 CBR	10034 ABR
10030 FBR	
10400 CBR	10404 ABR
10400 FBR	
10410 CBR	
10410 FBR	
10040 CBR	10044 ABR
10040 FBR	
10050 CBR	10054 ABR
10050 FBR	
10150 CBR	
10150 FBR	
10060 CBR	10064 ABR
10060 FBR	
10160 CBR	
10160 FBR	
10070 CBR	10074 ABR
10170 CBR	
10500 CBR	10504 ABR
10510 CBR	
10520 CBR	
10140 CBR	10144 ABR

МИНИКАНАЛ	АКСЕССУАР
10010 CBR	10015 ABR
10010 FBR	
10020 CBR	10025 ABR
10020 FBR	
10030 CBR	10035 ABR
10030 FBR	
10400 CBR	10405 ABR
10400 FBR	
10410 CBR	
10410 FBR	
10040 CBR	10045 ABR
10040 FBR	
10050 CBR	10055 ABR
10050 FBR	
10150 CBR	
10150 FBR	
10060 CBR	10065 ABR
10060 FBR	
10160 CBR	
10160 FBR	
10070 CBR	10075 ABR
10170 CBR	
10500 CBR	10505 ABR
10510 CBR	
10520 CBR	
10140 CBR	10145 ABR

МИНИКАНАЛ	АКСЕССУАР
10010 CBR	10016 ABR
10010 FBR	
10020 CBR	10026 ABR
10020 FBR	
10030 CBR	10036 ABR
10030 FBR	
10400 CBR	10406 ABR
10400 FBR	
10410 CBR	
10410 FBR	
10040 CBR	10046 ABR
10040 FBR	
10050 CBR	10056 ABR
10050 FBR	
10150 CBR	
10150 FBR	
10060 CBR	10066 ABR
10060 FBR	
10160 CBR	
10160 FBR	
10070 CBR	10076 ABR
10170 CBR	
10500 CBR	10506 ABR
10510 CBR	
10520 CBR	
10140 CBR	10146 ABR

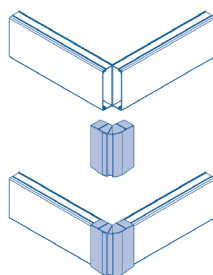
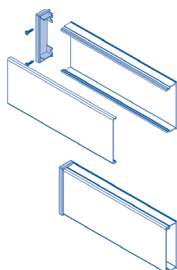
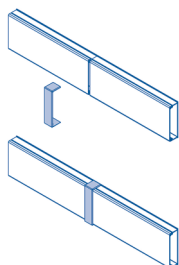

СБОРКА МЕХАНИЗМОВ

СЕРИЯ LOGUS 90 | SIRIUS 70 | APOLO 5000

1. Зафиксируйте кабельный канал и монтажную коробку.

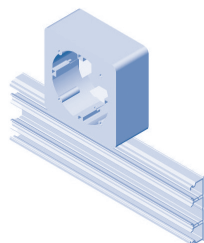

2. Зафиксируйте кабельный канал и монтажную коробку.

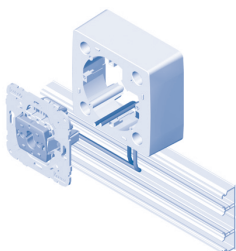

3. Подключите провода и установите механизм.

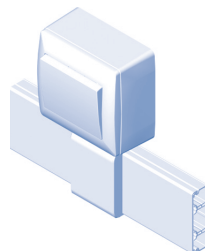

СЕРИЯ QUADRO 45 (с сечениями 60x16 и 75x20)

1. Зафиксируйте кабельный Канал, после чего установите Фронтальный адаптер Серия Q45.

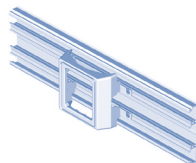

2. Подключите провода и установите механизм.

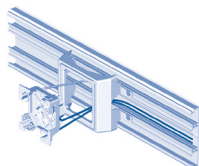

3. Установите крышку кабельного канала и накладку на механизм.

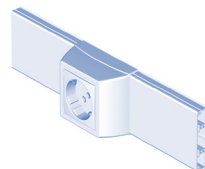

СЕРИЯ 3700

1. Зафиксируйте кабельный канал, после чего Зафиксируйте основу и механизм на стене.

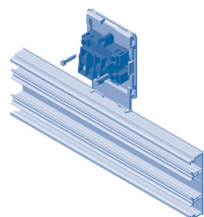

2. Подключите провода.

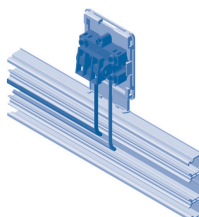

3. Установите суппорт, кнопки/накладки, крышку кабельного канала и адаптер.

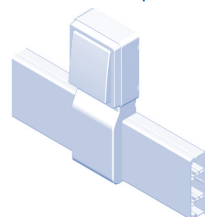

СЕРИЯ 47 (с сечениями 60x16 и 75x20)

1. Зафиксируйте кабельный канал и основу адаптера с механизмом на стене.

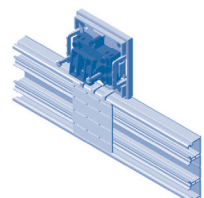

2. Удалите пластиковый элемент и подключите Провода.

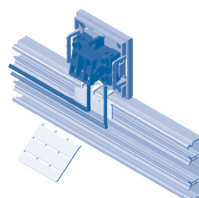

3. Установите крышку кабельного, адаптер, накладки/клавиши.

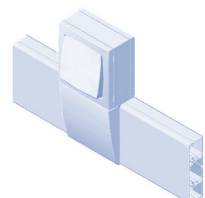

СПЕЦИАЛИЗИРОВАННЫЕ ЯЩИКИ

МОНТАЖНАЯ КОРОБКА ДЛЯ ОТКРЫТОГО МОНТАЖА МЕХАНИЗМОВ ИТАЛЬЯНСКОГО/АМЕРИКАНСКОГО ТИПОВ

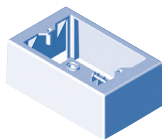

РАСПРЕДЕЛИТЕЛЬНАЯ КОРОБКА 80x80x20

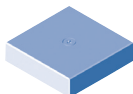

РАСПРЕДЕЛИТЕЛЬНАЯ КОРОБКА 80x80x30

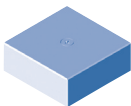

РАСПРЕДЕЛИТЕЛЬНАЯ КОРОБКА 110x110x50

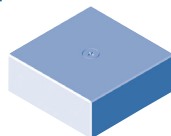

СТАНДАРТ EN 50085-2-1

РАЗДЕЛ 6	КЛАССИФИКАЦИЯ	СЕРИЯ 10 - МИНИКАНАЛЫ И КАБЕЛЬНЫЙ ПЛИНТУС	
6.2	Сопrotивление механическим нагрузкам	12x7	0,5J
		110x20	1J
		16x10 / 20x12,5 / 32x12,5 / 32x16 / 40x12,5 / 40x16 / 60x16 / 50x20 / 75x20	2J
6.3	Минимальная температура хранения и транспортировки	-25°C	
6.3	Минимальная температура при установке и эксплуатации	-5°C	
6.3	Максимальная температура при эксплуатации	60°C	
6.4	Устойчивость к распространению горения	Не распространяет	
6.5	Электропроводность	Не проводит	
6.6	Электрическая изоляция	Изолирует	
6.7	Степень пыле- и влагозащиты	IP44	
6.8	Защита против коррозии и загрязнений	Средний уровень защиты снаружи и внутри	
6.9	Доступ внутрь короба и снятие крышки	Снятие крышки возможно только при помощи инструмента	
6.10	Разделение электрических сетей	При помощи внутренней перегородки	
6.101	Варианты установки	Накладной монтаж на стене и/или потолке	
6.102	Случаи контакта жидкости и изолированных жил кабеля в кабельных плинтусах при влажной обработке пола.	Не зафиксированы	
6.103	Тип	3 (Установка)	
	Номинальное напряжение	500V~	



RoHS - все кабельные короба и аксессуары к ним, производимые компанией EFAPEL, полностью соответствуют требованиям Директивы RoHS 2011/65/UE, которая ограничивает использование ряда опасных веществ, таких как свинец, ртуть, кадмий, шестивалентный хром, полибромированные бифенилы (ПБП) и полибромированные дифенилэферы (ПБД). Компания EFAPEL оставляет за собой право изменять данный документ или описываемые им продукты без предупреждения. Если у вас появились сомнения, свяжитесь с нами.